

**Use & Care Manual**  
Clothes Dryer

EN 2

Manuel d'utilisation et d'entretien  
Sécheuse à Chargement Frontal

FR 52

Manual de uso y cuidado  
Secadora de ropa

SP 106



[electrolux.com/register](http://electrolux.com/register)

# 2

## IMPORTANT SAFETY INFORMATION

### Please read and save this manual

Thank you for choosing Electrolux, our premium brand in home appliances. This *Use & Care Manual* is part of our commitment to customer satisfaction and product quality throughout the service life of your new appliance.

We view your purchase as the beginning of a relationship. To ensure our ability to continue serving you, please use this page to record important product information.

### Keep a record for quick reference

Purchase date

Electrolux model number

Electrolux serial number

Electrolux model series\*

\*The series number can be found within the Model number (example ELFE7637AW = 600 series)

#### NOTE

Registering your product with Electrolux enhances our ability to serve you. You can register online at [www.electrolux.com](http://www.electrolux.com), by sending your Product Registration Card in the mail, or PHOTOREGISTER<sup>SM</sup> using a smart phone. See registration card for details.

### TABLE OF CONTENTS

Important Safety Information.....	2
Features.....	8
Pre-Installation Requirements.....	9
Installation.....	18
Accessories and Replacement Parts.....	29
Controls and Settings.....	30
Operating Instructions.....	41
Normal Operating Sounds.....	43
Care and Cleaning.....	44
Troubleshooting.....	46
Limited Warranty.....	49
Quebec Right to Repair.....	50

### Questions?

For toll free telephone support or online support in the US and Canada contact:

#### U.S.

1-877-4ELECTROLUX (1-877-435-3287)  
[www.electrolux.com](http://www.electrolux.com)

#### Canada

1-800-265-8352  
[www.electrolux.ca](http://www.electrolux.ca)

#### NOTE

The instructions appearing in this *Use & Care Manual* are not meant to cover every possible condition and situation that may occur. Common sense and caution must be practiced when installing, operating and maintaining any appliance.

**READ ALL INSTRUCTIONS BEFORE OPERATING THIS DRYER.**

**SAVE THESE INSTRUCTIONS FOR FUTURE REFERENCE.**

---

**Important safety instructions - gas dryer**

---

** WARNING****FIRE or explosion hazard**

**Failure to follow safety warning exactly could result in serious injury, death, or property damage.**

**DO NOT store or use gasoline or other flammable vapors and liquids in the vicinity of this or any other appliance.**

**WHAT TO DO IF YOU SMELL GAS:**

- **DO NOT try to light any appliance.**
- **DO NOT touch any electrical switch; DO NOT use any phone in your building.**
- **Clear the room, building or area of all occupants.**
- **Immediately call your gas supplier from a neighbor's phone. Follow the gas supplier's instructions.**
- **If you cannot reach your gas supplier, call the fire department.**

**Installation and service must be performed by a qualified installer, service agency or the gas supplier.**

** DANGER**

**If using Liquid Propane (LP), STOP and install the LP kit before operating your gas dryer.**

---



## **WARNING**

### **RISK OF FIRE**

- **Ensure the entire dryer exhaust system is clean and free of lint and debris prior to the installation of your new dryer. The entire exhaust system should be inspected and cleaned a minimum of every 18 months with normal usage. Failure to comply with cleaning your exhaust system will increase the RISK of FIRE.**
- DO NOT install a clothes dryer with flexible plastic or flexible foil venting material. Flexible venting materials are known to collapse, be easily crushed and trap lint. These conditions will obstruct clothes dryer airflow and increase the risk of fire.
- DO NOT screen the exhaust ends of the vent system, or use any screws, rivets or other fasteners that extend into the duct to assemble the exhaust system. NO screen or grate of any mesh size is allowed to cover the outdoor exhaust opening.
- Install the clothes dryer according to the manufacturer's instructions and local codes.
- Clothes dryer installation and service must be performed by a qualified installer, service agency or the gas supplier.
- The electrical service to the dryer must conform with local codes and ordinances and the latest edition of the National Electrical Code, ANSI/NFPA 70, or in Canada, the Canadian Electrical Code CSA C22.1 part 1.
- The gas service to the dryer must conform with local codes and ordinances and the latest edition of the National Fuel Gas Code ANSI Z223.1/NFPA 54, or in Canada, the Natural Gas and Propane Installation Code, CSA B149.1. An individual manual shutoff valve must be installed within 6 ft. (1.83 m) of the dryer in accordance with the National Fuel Gas Code, ANSI Z223.1/NFPA 54.
- DO NOT stack a dryer on top of washer already installed on pedestal. DO NOT stack washer on top of dryer. DO NOT stack washer on top of another washer.
- The dryer is designed under ANSI Z21.5.1/CSA 7.1 or UL 2158 - CAN/CSA C22.2 No. 112 (latest editions) for HOME USE only. This dryer is not recommended for commercial applications such as restaurants, beauty salons, etc.
- Destroy the carton and plastic bags after the dryer is unpacked. Children might use them to play. Cartons covered with rugs, bedspreads, or plastic sheets can become airtight chambers causing suffocation. Place all materials in a garbage container or make materials inaccessible to children.
- To reduce the risk of severe injury or death, follow all installation instructions in this manual.

The instructions in this manual and all other literature included with this dryer are not meant to cover every possible condition and situation that may occur. Good safe practice and caution **MUST** be applied when installing, operating and maintaining any appliance.



### **WARNING**

For your safety, the information in this manual must be followed to minimize the risk of fire or explosion or to prevent property damage, personal injury or loss of life. DO NOT store or use gasoline or other flammable vapors and liquids in the vicinity of this or any other appliance.

## IMPORTANT SAFETY INFORMATION

### Definitions

 This is the safety alert symbol. It is used to alert you to potential personal injury hazards. Obey all safety messages that follow this symbol to avoid possible injury or death.



#### DANGER

DANGER indicates an imminently hazardous situation which, if not avoided, will result in death or serious injury.



#### WARNING

WARNING indicates a potentially hazardous situation which, if not avoided, could result in death or serious injury.



#### CAUTION

CAUTION indicates a potentially hazardous situation which, if not avoided, may result in minor or moderate injury.



#### IMPORTANT

IMPORTANT indicates installation, operation or maintenance information which is important but not hazard-related.



#### WARNING

##### FIRE HAZARD

To reduce the risk of fire, electrical shock, or injury to persons when using this dryer, comply with the basic warnings listed below. Failure to comply with the Important Safety Instruction warnings could result in property damage, serious personal injury, or death.

### Prevent fire

- DO NOT dry items that have been previously cleaned in, soaked in, or spotted with gasoline, cleaning solvents, kerosene, waxes, or other flammable or explosive substances. DO NOT store these items on or near the dryer. These substances give off vapors that could ignite or explode.
- DO NOT place items exposed to cooking oils in your dryer. Items contaminated with cooking oils may contribute to a chemical reaction that could cause a load to catch fire. To reduce the risk of fire due to contaminated loads, the final part of a tumble dryer cycle occurs without heat (cool down period). Avoid stopping a tumble dryer before the end of the drying cycle unless all items are quickly removed and spread out so that the heat is dissipated.
- DO NOT dry articles containing rubber, plastic or similar materials such as bras, galoshes, bath mats, rugs, bibs, baby pants, plastic bags and pillows that may melt or burn. Some rubber materials, when heated, can under certain circumstances produce fire by spontaneous combustion.
- DO NOT operate the dryer if the lint screen is blocked, damaged or missing. Fire hazard, overheating and damage to fabrics can occur.
- DO NOT obstruct the flow of ventilating air. DO NOT stack or place laundry or throw rugs against the front or back of the dryer.



#### WARNING

##### FIRE HAZARD

Clean the lint screen before or after each load. **The interior of the dryer, lint screen housing and exhaust duct should be cleaned approximately every 18 months by qualified service professional.** An excessive amount of lint build-up in these areas could result in inefficient drying and possible fire. See *Care and Cleaning*.



#### WARNING

##### FIRE HAZARD

A clothes dryer produces combustible lint. The dryer must be connected to an outdoor exhaust. Regularly inspect the outdoor exhaust opening and remove any accumulation of lint around the opening and in the surrounding area.

- DO NOT spray any type of aerosol into, on or near dryer at any time.

# 6

## IMPORTANT SAFETY INFORMATION

---

- DO NOT use fabric softeners or products to eliminate static unless recommended by the manufacturer of the fabric softener or product.



### WARNING

DO NOT continue to use the dryer if you hear squeaking, grinding, rubbing or other unusual noises. This could be a sign of mechanical breakdown and lead to fire or serious injury. **Contact a qualified technician immediately.**

- Failure to comply with these warnings could result in fire, explosion, serious bodily injury and/or damage to the dryer.

### Protect children

- DO NOT allow children to play on or in the dryer. Close supervision of children is necessary when the dryer is used near children. As children grow, teach them the proper, safe use of all appliances.
- Destroy the carton, plastic bag and other packing materials after the dryer is unpacked. Children might use them for play. Cartons covered with rugs, bedspreads or plastic sheets can become airtight chambers.
- Keep laundry products out of children's reach. To prevent personal injury, observe all warnings on product labels.
- Before the dryer is removed from service or discarded, remove the dryer door to prevent accidental entrapment.
- Failure to comply with these warnings could result in serious personal injuries.

### Risk of child entrapment

Child entrapment and suffocation are not problems of the past. Junked or abandoned washers and dryers are still dangerous – even if they will sit for “just a few days”. If you are getting rid of your old washer or dryer, please follow the instructions below to help prevent accidents.

We strongly encourage responsible appliance recycling/disposal methods. Contact your State/Providence Energy Office, Local Electric and Water Utilities or

Conservation Program Office or visit [www.energystar.gov/recycle](http://www.energystar.gov/recycle) for more information on recycling your old washer or dryer.

### Before you throw away your old washer or dryer:

- Remove doors
- Remove the electric power cord
- Secure all hoses and drain pipes to prevent water from leaking out and creating a slip hazard.

### Prevent injury

- To prevent shock hazard and assure stability during operation, the dryer must be installed and electrically grounded by a qualified service person in accordance with local codes. Installation instructions are included in this manual for reference. Refer to the *installation sections* for detailed grounding procedures. If the dryer is moved to a new location, have it checked and reinstalled by a qualified service professional.
- To prevent personal injury or damage to the dryer, the electrical power cord of a gas dryer must be plugged into a properly grounded and polarized 3-prong outlet. The third grounding prong must never be removed. Never ground the dryer to a gas pipe. DO NOT use an extension cord or an adapter plug.
- ALWAYS disconnect the dryer from the electrical supply before attempting any service or cleaning. Failure to do so can result in electrical shock or injury.
- DO NOT use any type of spray cleanser when cleaning dryer interior. Hazardous fumes or electrical shock could occur.
- To prevent injury, DO NOT reach into the dryer if the drum is moving. Wait until the dryer has stopped completely before reaching into the drum.

### Prevent injury and damage to the dryer

- All repairs and servicing must be performed by an authorized service provider unless specifically recommended in this *Use & Care Manual*. Use only authorized factory parts.
- DO NOT tamper with controls.
- DO NOT sit on, step on or stand on the dryer. DO NOT rest heavy loads on top. The dryer is not meant to support weight.

# IMPORTANT SAFETY INFORMATION

- DO NOT install or store the dryer where it will be exposed to standing water, dripping water or outdoor weather conditions.
- Thermal limiter switches automatically turn off the motor in the unlikely event of an overheated situation. A service technician must replace the thermal limiter switch(es) after correcting the fault
- Failure to comply with these warnings could result in serious personal injuries.
- Do not use replacement parts that have not been recommended by the manufacturer (e.g. parts made at home using a 3D printer).



## WARNING

### FIRE/ELECTRICAL SHOCK HAZARD

Avoid fire hazard or electrical shock. DO NOT use an adapter plug or extension cord or remove grounding prong from electrical power cord. Failure to follow this warning can cause serious injury, fire, or death.

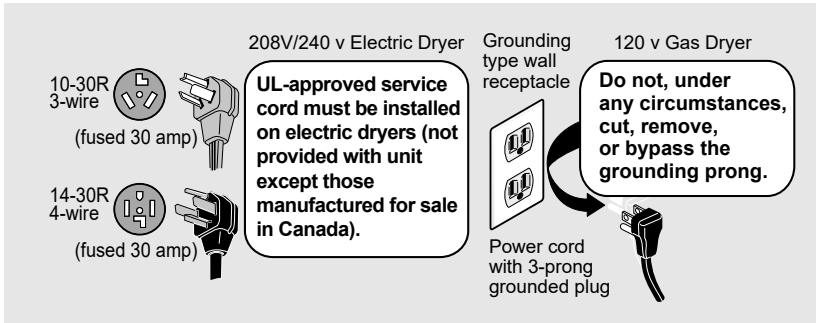

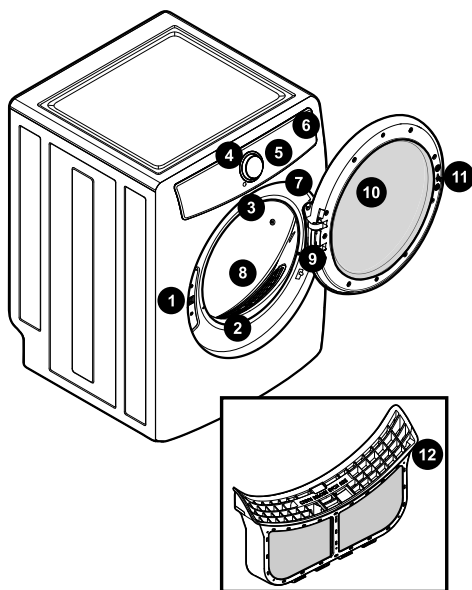

**Not all cycles, options, or features listed are available on every model.**

1. Door Latch	7. Serial Number and Model Number
2. Front-Mounted Moisture Sensor (on select models)	8. 3 Drum Vanes
3. Drum Light (on select models)	9. Wide-Angle Door Hinge
4. Cycle Selector	10. Reversible Door
5. LED Display	11. Door Striker
6. Control Lock	12. LuxCare™ Lint Shield

Refer to the table below for an overview of features available for each model series.

	Anti Static	Perfect Steam	Wrinkle Release	Extended Tumble	Drum Light	Delay Time	Control Lock	Allergen	Wear it Again	Sanitize	Eco Dry	Fast Dry
<b>300 Series</b>	No	No	Yes	Yes	No	Yes	Yes	No	No	No	Yes	20 min
<b>400 Series*</b>	No	Yes	Yes	Yes	Yes	Yes	Yes	No	No	Yes	Yes	18 min
<b>500 Series</b>	Yes	Yes	Yes	Yes	Yes	Yes	Yes	Yes	No	Yes	Yes	15 min
<b>600 Series</b>	Yes	Yes	Yes	Yes	Yes	Yes	Yes	Yes	No	Yes	Yes	15 min
<b>700 Series</b>	Yes	Yes	Yes	Yes	Yes	Yes	Yes	No	Yes	Yes	Yes	15 min

\* For Series 400, Drum Light is available in White models only.



## Installation Checklist

### Exhaust Venting

- Free-flowing, clear of lint buildup
- 4 inch (102 mm) rigid metal or semi-rigid metal transition ducting of minimal length and turns
- NO foil or plastic venting material
- Approved vent hood exhausted to outdoors

### Leveling

- Dryer is level, side-to-side and front-to-back
- Cabinet is sitting solid on all corners

### Gas Supply (Gas Dryer)

- Manual shutoff valve present in supply
- All connections sealed with approved sealer and wrench tight
- Conversion kit for LP GAS system # PCK4200 (not included) and must be purchased separately
- Gas supply turned on
- No leaks present at all connections - check with soapy water, NEVER check with flame

### Water Hookup (Select Models)

- Inspect hoses for proper placement of rubber washers
- Water supply is turned on

- Check for leaks
- Steam model dryers require use of ASSEMBLY HOSE Kit #5304495002 (not included) and must be purchased separately.

### 240v Electric Supply (Electric Dryer)

- Approved NEMA 10-30 or 14-30 service cord with all screws tight on terminal block
- Approved strain relief installed
- Terminal access cover installed before initial operation

### Door Reversal

- Follow detailed instructions in this manual
- Test hinge and latch for function

### Electrical Power

- House power turned on
- Dryer plugged in

### Final Checks

- Installation Instructions and Use & Care Manual read thoroughly
- Door latches and drum tumbles when cycle starts
- Registration card sent in

### Tools and materials needed for installation:

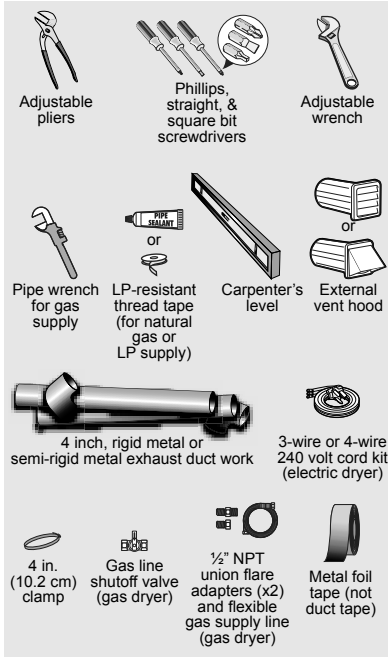

ASSEMBLY HOSE KIT - P/N 5304495002, for steam models only, is not included and must be purchased separately.

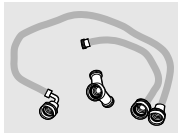

### Electrical system requirements

#### NOTE

Because of potentially inconsistent voltage capabilities, the use of this dryer with power created by gas powered generators, solar powered generators, wind powered generators or any other generator other than the local utility company is not recommended.

#### Electrical requirements for electric dryer:

**CIRCUIT** - Individual 30 amp. branch circuit fused with 30 amp. time delay fuses or circuit breakers. Use separately fused circuits for washer and dryer. **DO NOT** operate washer and dryer on same circuit.

**POWER SUPPLY** - 3-wire or 4-wire, 120/240 volt, single phase, 60 Hz, Alternating Current

#### NOTE

A 120/208 volt, single phase, 60 Hz, Alternating Current supply may be used on dryers marked for use on rating plate.

#### NOTE

The electric dryer has been designed and certified to operate at both 240V and 208V. Drying times on a 208V power supply will, however, be approximately 20% longer than drying times on a 240V power supply. This is normal and expected behavior and applies to all drying cycles.

#### IMPORTANT

Dryer is internally grounded to neutral unless it was manufactured for sale in Canada.

Only a 4-conductor cord shall be used when the appliance is installed in a location where grounding through the neutral conductor is prohibited. Grounding through the neutral link is prohibited for: (1) new branch circuit installations, (2) mobile homes, (3) recreational vehicles, and (4) areas where local codes **DO NOT** permit grounding through the neutral.



#### WARNING

##### FIRE HAZARD

- Failure to follow safety warnings exactly could result in serious injury, death, or property damage.
- **DO NOT** install a booster fan in dryer exhaust duct.
- Install all clothes dryers in accordance with the installation instructions in this manual.

## PRE-INSTALLATION REQUIREMENTS

### 3-wire power supply cord (not supplied)



**3-wire receptacle  
(NEMA type 10-30R)**

The dryer MUST employ a 3-conductor power supply cord NEMA 10-30 type SRDT rated at 240 volt AC minimum, 30 amp, with 3 open end spade lug connectors with upturned ends or closed loop connectors and marked for use with clothes dryers. For 3-wire cord connection instructions see "Electrical connection (non-Canada) - 3-wire cord" in Electrical Installation section.

**OUTLET RECEPTACLE** - NEMA 10-30R receptacle to be located so the power supply cord is accessible when the dryer is in the installed position.

**GROUNDING CONNECTION** - See "Grounding requirements" in Electrical Installation section.

### 4-wire power supply cord (not supplied)



**4-wire receptacle  
(NEMA type 14-30R)**

The dryer MUST employ a 4-conductor power supply cord NEMA 14-30 type SRDT or DRT (as required) rated at 240 volt AC minimum, 30 amp, with 4 open end spade lug connectors with upturned ends or closed loop connectors and marked for use with clothes dryers. For 4-wire cord connection instructions see "Electrical connection (non-Canada) - 4-wire cord" in Electrical Installation section.



#### NOTE

Dryers manufactured for sale in Canada have factory-installed, 4-wire power supply cord (NEMA 14-30).

**OUTLET RECEPTACLE** - NEMA 14-30R receptacle to be located so the power supply cord is accessible when the dryer is in the installed position.

**GROUNDING CONNECTION** - See "Grounding requirements" in Electrical Installation section.

### Electrical requirements for gas dryer:

**CIRCUIT** - Individual, properly polarized and grounded 15 amp. branch circuit fused with 15 amp. time delay fuse or circuit breaker.

**POWER SUPPLY** - 2-wire, with ground, 120 volt, single phase, 60 Hz, Alternating Current.

**POWER SUPPLY CORD** - Dryer is equipped with 120 volt 3-wire power cord.

**GROUNDING CONNECTION** - See "Grounding requirements" in Electrical Installation section.



#### WARNING

Improper grounding of the dryer may cause serious injury or death. Check with a licensed electrician if you are in doubt as to whether the appliance is properly grounded.

Grounding type wall receptacle

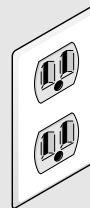

**Do not, under any circumstances, cut, remove, or bypass the grounding prong.**

Power cord with 3-prong grounded plug

### Gas supply requirements



#### WARNING

##### EXPLOSION HAZARD

Uncoated copper tubing will corrode when subjected to natural gas, causing gas leaks. Use **ONLY** black iron, stainless steel, or plastic-coated brass piping for gas supply.

1. The gas service to the dryer must conform with local codes and ordinances and the latest edition of the National Fuel Gas Code ANSI Z223.1/
2. NFPA 54, or in Canada, the Natural Gas and Propane Installation Code, CSA B149.1.
3. The gas supply line should be 1/2 inch (1.27 cm) pipe.
4. If codes allow, flexible metal tubing may be used to connect your dryer to the gas supply line. The tubing **MUST** be constructed of stainless steel or plastic-coated brass.
5. The gas supply line **MUST** have an individual shutoff valve installed in accordance with the B149.1, Natural Gas and Propane Installation Code.
6. A 1/8 inch (0.32 cm) N.P.T. plugged tapping, accessible for test gauge connection, **MUST** be installed immediately upstream of the gas supply connection to the dryer.
7. The dryer **MUST** be disconnected from the gas supply piping system during any pressure testing of the gas supply piping system at test pressures in excess of 1/2 psig (3.45 kPa).
8. The dryer **MUST** be isolated from the gas supply piping system during any pressure testing of the gas supply piping system at test pressures equal to or less than 1/2 psig (3.45 kPa).
9. Connections for the gas supply must comply with the Standard for Connectors for Gas Appliances, ANSI Z21.24/CSA 6.10.

**WARNING****FIRE HAZARD**

Failure to follow these instructions can create excessive drying times and fire hazards.

**The following are specific requirements for proper and safe operation of your dryer.**

**WARNING****FIRE HAZARD**

- Failure to follow safety warnings exactly could result in serious injury, death, or property damage.
- **DO NOT** install a booster fan in dryer exhaust duct.
- Install all clothes dryers in accordance with the installation instructions in this manual.

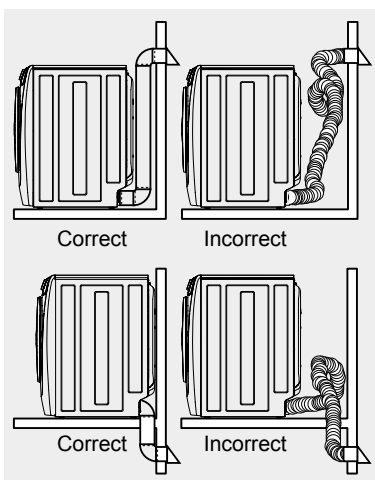

## Exhaust system requirements

Use only 4 inch (102 mm) diameter (minimum) rigid or semi rigid metal duct and approved vent hood which has a swing-out damper or dampers that open when the dryer is in operation. When the dryer stops, the damper or dampers automatically close to prevent drafts and the entrance of insects and rodents. To avoid restricting the outlet, maintain a minimum of 12 inches (30.5 cm) clearance between the vent hood and the ground or any other obstruction.



## WARNING

### FIRE HAZARD

- A clothes dryer must be exhausted outdoors.
- **DO NOT** exhaust dryer into a chimney, a wall, a ceiling, an attic, a crawl space or any concealed space of a building.
- A clothes dryer produces combustible lint. If the dryer is not exhausted outdoors, some fine lint will be expelled into the laundry area. An accumulation of lint in any area of the home can create a health and fire hazard.
- The dryer must be connected to an exhaust outdoors.
- Regularly inspect the outdoor exhaust opening and remove any accumulation of lint around the outdoor exhaust opening and in the surrounding area.



## WARNING

### FIRE HAZARD



- **DO NOT** allow combustible materials (for example: clothing, draperies/curtains, paper) to come in contact with exhaust system. The dryer **MUST NOT** be exhausted into any gas vent a chimney, a wall, a ceiling, or any concealed space of a building which can accumulate lint, resulting in a fire hazard.
- **DO NOT** screen the exhaust ends of the vent system, or use any screws, rivets or other fasteners that extend into the duct to assemble the exhaust system. **No screen, grate, or guard of any mesh size is allowed to cover the exhaust opening. Lint can become caught in the screen, grate, guard, or on the screws or rivets, clogging the duct work and creating a fire hazard as well as increasing drying times.** Use an approved vent hood to terminate the duct outdoors, and seal all joints with metal foil tape. All male duct pipe fittings **MUST** be installed downstream with the flow of air.



## WARNING

### FIRE HAZARD

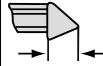
Never exceed more than 4-90° elbows in the exhaust duct system. Exceeding the length of duct pipe or number of elbows allowed in the "MAXIMUM LENGTH" charts can cause an accumulation of lint in the exhaust system. Plugging the system could create a fire hazard, as well as increase drying times.

Max. Number of 90° turns	MAXIMUM LENGTH of 4" (102 mm) Rigid Metal Duct	
	VENT HOOD TYPE	
	(Preferred)	
		
	4" (10.2 cm)	louvered 2.5" (6.35 cm)
0	125 ft. (38 m)	110 ft. (33.5 m)
1	115 ft. (35 m)	100 ft. (30.5 m)
2	105 ft. (32 m)	90 ft. (27.5 m)
3	95 ft. (29 m)	80 ft. (24.5 m)
4	85 ft. (26 m)	70 ft. (21.5 m)



## WARNING

### FIRE HAZARD

- **DO NOT** install flexible plastic or flexible foil venting material.
- **DO NOT** exceed 8 ft. (2.4 m) duct length if installing semi-rigid venting.
- **DO NOT** use screws, rivets or other fasteners that extend into the duct to assemble the exhaust system.

## Exhaust direction

Directional exhausting can be accomplished by installing a quick-turn 90° dryer vent elbow directly to exhaust outlet of dryer. Dryer vent elbows are available through your local parts distributor or hardware store.

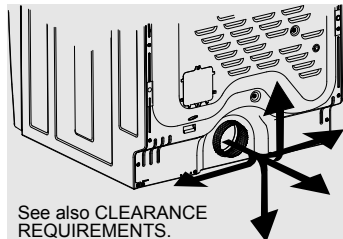

See also CLEARANCE REQUIREMENTS.

## NOTE

Use of 90° quick-turn elbow required to meet minimum installation depth.



## WARNING

### FIRE HAZARD

**DO NOT** install the dryer where gasoline or other flammables are kept or stored. If the dryer is installed in a garage, it must be a minimum of 18 inches (45.7 cm) above the floor. Failure to do so can result in death, explosion, fire or burns.

In installations where the exhaust system is not described in the charts, the following method must be used to determine if the exhaust system is acceptable:

1. Connect an inclined or digital manometer between the dryer and the point the exhaust connects to the dryer.
2. Set the dryer timer and temperature to **air fluff** (cool down) and start the dryer.
3. Read the measurement on the manometer.
4. The system back pressure MUST NOT be higher than 1.0 inch of water column. If the system back pressure is less than 1.0 inch of water column, the system is acceptable. If the manometer reading is higher than 1.0 inch of water column, the system is too restrictive and the installation is unacceptable.

Install male fittings in correct direction:

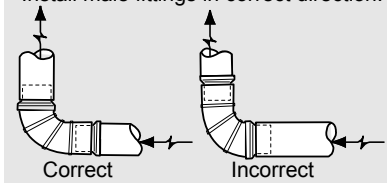

Although vertical orientation of the exhaust system is acceptable, certain extenuating circumstances could affect the performance of the dryer:

- Only the rigid metal duct work should be used.
- Venting vertically through a roof may expose the exhaust system to down drafts causing an increase in vent restriction.

- Running the exhaust system through an uninsulated area may cause condensation and faster accumulation of lint.
- Compression or crimping of the exhaust system will cause an increase in vent restriction.
- **The exhaust system should be inspected and cleaned a minimum of every 18 months with normal usage.** The more the dryer is used, the more often you should check the exhaust system and vent hood for proper operation and that it is free of obstructions.

## Manufactured or mobile home installation

1. Installation MUST conform to current Manufactured Home Construction & Safety Standard, Title 24 CFR, Part 32-80 (formerly the Federal Standard for Mobile Home Construction and Safety for Mobile Homes, Title 24, HUD Part 280) or Standard CAN/CSAZ240 MH.
2. Dryer MUST be exhausted outside (outdoors, not beneath the mobile home) using metal ducting that will not support combustion. Metal ducting must be 4 inches (10.16 cm) in diameter with no obstructions. Rigid metal duct is preferred.
3. If dryer is exhausted through the floor and area beneath the mobile home is enclosed, the exhaust system MUST terminate outside the enclosure with the termination securely fastened to a non-combustible portion of the mobile home structure.
4. Refer to previous sections in this manual for other important exhaust venting system requirements.
5. When installing a gas dryer into a mobile home, a provision must be made for outside make up air. This provision is to be not less than twice the area of the dryer exhaust outlet.
6. Installer MUST anchor this (1) dryer or (2) dryer mounted on pedestal to the floor with approved Mobile Home Installation Kit - P/N 137067200.

Clearance requirements



IMPORTANT

DO NOT INSTALL YOUR DRYER:

1. In an area exposed to standing water, dripping water, or outside weather conditions.
2. In an area where it will come in contact with curtains, drapes, or anything that will obstruct the flow of combustion and ventilation air.
3. On carpet. Floor **MUST** be solid with a maximum slope of 1 inch (2.5 cm)

Installation in a recess or closet

1. A dryer installed in a recess or closet, **MUST** be exhausted outdoors.
2. No other fuel burning appliance shall be installed in the same recess or closet as a gas dryer.
3. Your dryer needs space around it for proper ventilation. See "Clearance Requirements" chart
4. A minimum of 120 square inches of inlet ventilation opening to the recess or closet is required for proper air flow to the dryer.
5. Inlet air ventilation to the recess or closet can be satisfied by adding 120 square inches of opening, equally divided at the top and bottom of the door and located 3 inches from the bottom and top of the door.

or, adding 120 square inches of ventilation openings to the top, sides or rear wall of the closet wall, if the wall is adjacent to an open room, hallway, or exterior.

or, a louvered door with equivalent air openings equaling 120 sq. inches of ventilation for the full length of the door is acceptable.

It is **NOT** approved to derive the 120 sq. inches of ventilation from the space between the door edges and the casing or the floor.

\*\* The presence of forced heating and air-conditioning vent openings in the closet does **NOT** satisfy the 120 square inch ventilation requirement to the closet.



NOTE

To achieve an installation with 0" (0 cm) clearance for the back of the dryer (for other than straight back venting), a quick-turn 90° dryer vent elbow must be installed as described previously in this manual.

For other than straight back venting, a quick-turn 90° dryer vent elbow must be installed to achieve 0" (0 cm) installation.

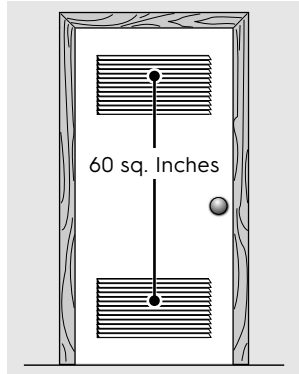

120 sq. Inches Equally Divided Split Vent Door

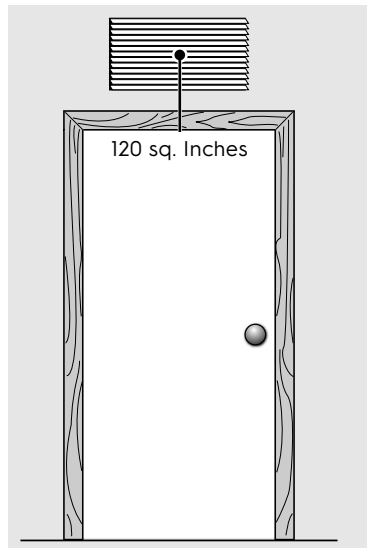

Solid Door with Wall Ventilation

# 16

## PRE-INSTALLATION REQUIREMENTS

120 sq. Inches min.  
Louvered Opening

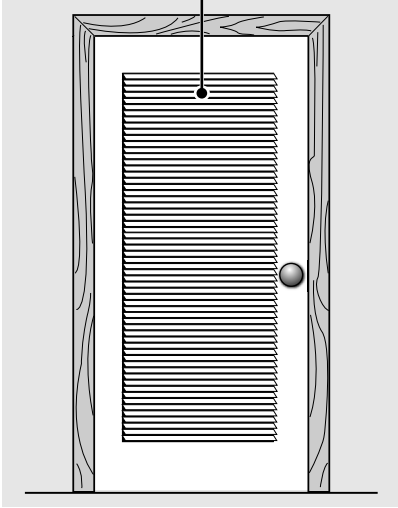

Louvered Door

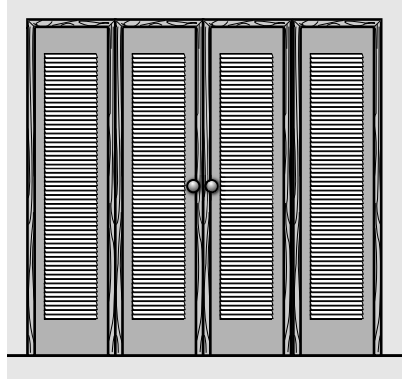

Bi-Fold louvered doors with  
120 sq. in of ventilation

120 sq. Inches of  
wall venting

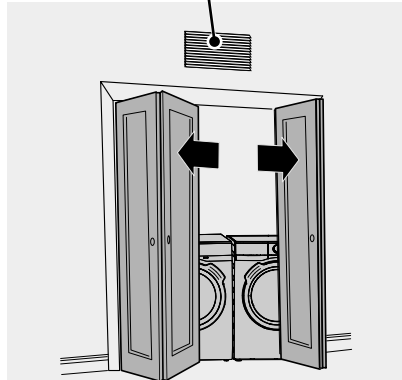

Solid Bi-Fold doors with no  
ventilation

### MIN INSTALLATION CLEARANCES - Inches (cm)

	Sides	Rear	Top	Front
Alcove/ recess	0" (0 cm)	0" (0 cm)	0" (0 cm)	Open
Closet with door vent	0" (0 cm)	0" (0 cm)	0" (0 cm)	1" (2.5 cm)
Closet with wall vent	1" (2.5 cm)	1" (2.5 cm)	1" (2.5 cm)	1" (2.5 cm)

## Dryer dimensions

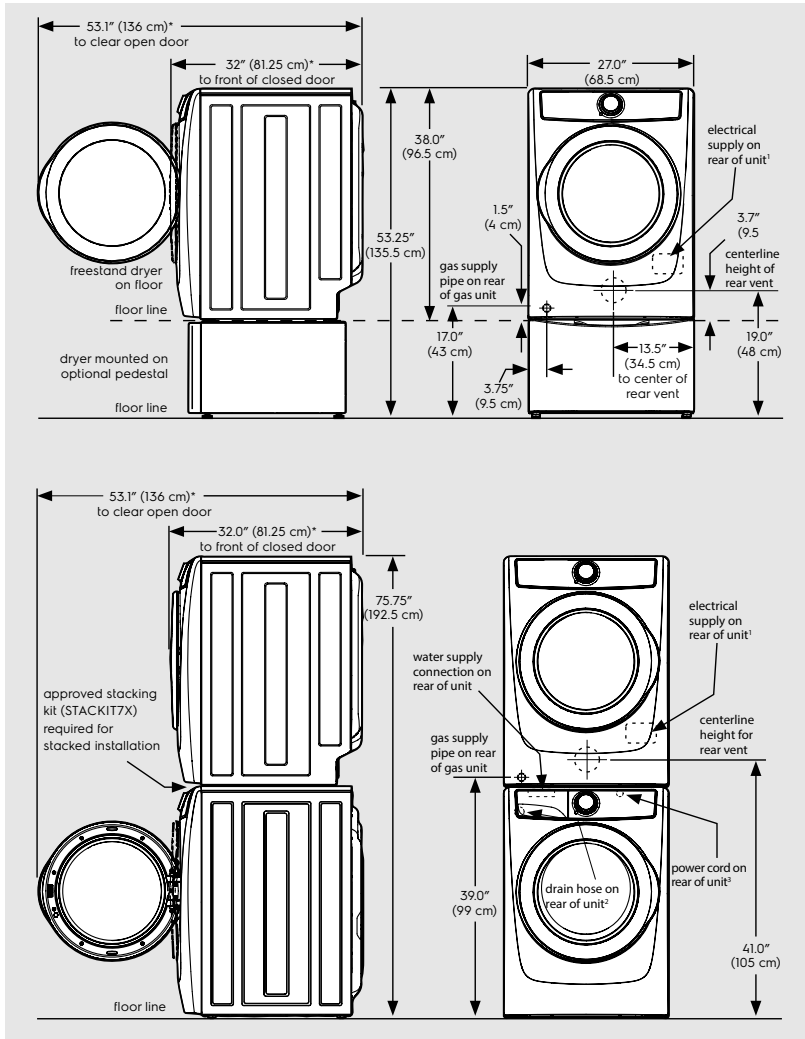

\* Connection of water inlet hose on steam dryer adds 3/4 in. (2 cm) to installation depth.

<sup>1</sup> Power supply cord length on gas dryer or electric Canadian dryer approximately 60 inches (152.5 cm).

<sup>2</sup> Drain hose length on washer approximately 59 inches (150 cm).

<sup>3</sup> Power supply cord length on washer approximately 60 inches (152.5 cm).

## Connecting the electrical system

The following are specific requirements for proper and safe electrical installation of your dryer. Failure to follow these instructions can create electrical shock and/or a fire hazard.



### WARNING

#### ELECTRICAL SHOCK HAZARD

- This appliance **MUST** be properly grounded. Electrical shock can result if the dryer is not properly grounded. Follow the instructions in this manual for proper grounding.
- **DO NOT** use an extension cord with this dryer. Some extension cords are not designed to withstand the amounts of electrical current this dryer utilizes and can melt, creating electrical shock and/or fire hazard. Locate the dryer within reach of the receptacle for the length power cord to be purchased, allowing some slack in the cord. Refer to the *Pre-Installation Requirements* section of this manual for the proper power cord to be purchased.



### WARNING

#### ELECTRICAL SHOCK HAZARD

- A U.L.-approved strain relief must be installed onto power cord. If the strain relief is not attached, the cord can be pulled out of the dryer and can be cut by any movement of the cord, resulting in electrical shock.
- **DO NOT** use an aluminum wired receptacle with a copper wired power cord and plug (or vice versa). A chemical reaction occurs between copper and aluminum and can cause electrical shorts. The proper wiring and receptacle is a copper wired power cord with a copper wired receptacle.



### NOTE

Dryers operating on 208 volt power supply will have longer drying times than dryers operating on 240 volt power supply.

The dryer, when installed, must be electrically grounded in accordance with local codes and the National Electrical code ANSI/NFPA 70 or the Canadian Electrical Code, Part 1, CSA C22.1.

## Grounding requirements - electric dryer (USA)



### WARNING

Improper grounding of the dryer may cause serious injury or death. Check with a licensed electrician if you are in doubt as to whether the appliance is properly grounded.

### For a grounded, cord-connected dryer:

1. The dryer **MUST** be grounded. In the event of a malfunction or breakdown, grounding will reduce the risk of electrical shock by providing a path of least resistance for electrical current.
2. After you purchase and install a 3-wire or 4-wire power supply cord having an equipment-grounding conductor and a grounding plug that matches your wiring system, the plug **MUST** be plugged into an appropriate, copper wired receptacle that is properly installed and grounded in accordance with all local codes and ordinances. If in doubt, call a licensed electrician.
3. **DO NOT** modify the plug you've installed on this appliance. If it will not fit the outlet, have a proper outlet installed by a qualified electrician.

### For a permanently connected dryer:

The dryer **MUST** be connected to a grounded metal, permanent wiring system; or an equipment grounding conductor must be run with the circuit conductors and connected to the equipment-grounding terminal or lead on the appliance.

## Grounding requirements - electric dryer (Canada)



### WARNING

Improper grounding of the dryer may cause serious injury or death. Check with a licensed electrician if you are in doubt as to whether the appliance is properly grounded.

### For a grounded, cord-connected dryer:

1. The dryer **MUST** be grounded. In the event of a malfunction or breakdown, grounding will reduce the risk of electrical shock by providing a path of least resistance for electrical current.
2. Since your dryer is equipped with a power supply cord having an equipment-grounding conductor and a grounding plug, the plug must be plugged into an appropriate outlet that is properly installed and grounded in accordance with all local codes and ordinances. If in doubt, call a licensed electrician.
- 3 **DO NOT** modify the plug provided with this appliance. If it will not fit the outlet, have a proper outlet installed by a qualified electrician.

## Grounding requirements - gas dryer

1. The dryer is equipped with a three-prong (grounding) plug for your protection against shock hazard and should be plugged directly into a properly grounded three-prong receptacle.
2. The plug must be plugged into an appropriate outlet that is properly installed and grounded in accordance with all local codes and ordinances. If in doubt, call a licensed electrician.
- 3 **DO NOT** modify the plug provided with this appliance. If it will not fit the outlet, have a proper outlet installed by a qualified electrician.



### WARNING

Improper grounding of the dryer may cause serious injury or death. Check with a licensed electrician if you are in doubt as to whether the appliance is properly grounded.

Grounding type wall receptacle

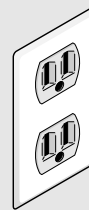

**Do not, under any circumstances, cut, remove, or bypass the grounding prong.**

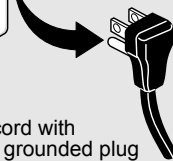

Power cord with  
3-prong grounded plug

### Electrical connection (non-Canada) - 3 wire cord



3-wire receptacle  
(NEMA type 10-30R)



#### WARNING

##### ELECTRICAL SHOCK HAZARD

Failure to disconnect power source before servicing could result in personal injury or even death.



#### WARNING

##### ELECTRICAL HAZARD

Label all wires prior to disconnection when servicing controls. Wiring errors can cause improper and dangerous operation. Verify proper operation after servicing.

1. Turn off power supply to outlet
2. Remove the screw securing the terminal block access cover in the lower corner on the back of the dryer.
3. Install a UL-approved strain relief according to the power cord/strain relief manufacturer's instructions in the power cord entry hole below the access panel. At this time, the strain relief should be loosely in place.
4. Thread an UNPLUGGED, UL-approved, 30 amp. power cord, NEMA 10-30 type SRDT, through the strain relief.
5. Attach the power cord neutral (center wire) conductor to the SILVER colored center terminal on the terminal block. Tighten the screw securely.
6. Attach the remaining two power cord outer conductors to the outer, BRASS colored terminals on the terminal block. Tighten both screws securely.



#### WARNING

##### ELECTRICAL SHOCK HAZARD

**DO NOT** make a sharp bend or crimp wiring/conductor at connections.

7. Follow manufacturer's guidelines for firmly securing the strain relief and power cord.
8. Reinstall the terminal block cover.



#### IMPORTANT

If moving dryer from a 4-wire system and installing it in a 3-wire system, move the internal ground from the center terminal back to the GREEN screw next to the terminal block.

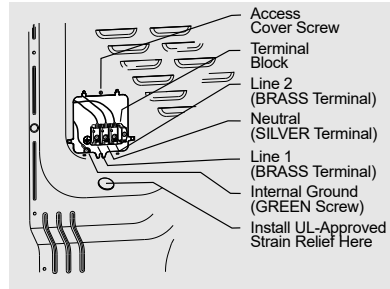
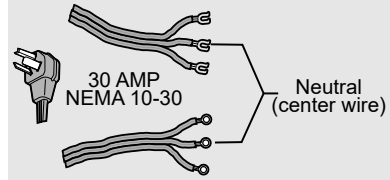

**DO NOT** remove internal ground in a 3-wire system!!

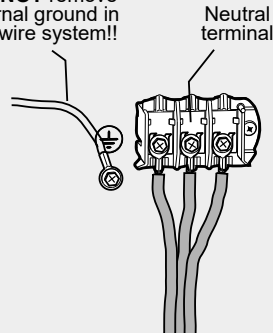

## Electrical connection (non-Canada) - 4 wire cord



4-wire receptacle  
(NEMA type 14-30R)



### WARNING

#### ELECTRICAL SHOCK HAZARD

Failure to disconnect power source before servicing could result in personal injury or even death.



### WARNING

#### ELECTRICAL HAZARD

Label all wires prior to disconnection when servicing controls. Wiring errors can cause improper and dangerous operation. Verify proper operation after servicing.

1. Turn off power supply to outlet.
2. Remove the screw securing the terminal block access cover in the lower corner on the back of the dryer.
3. Install a UL-approved strain relief according to the power cord/strain relief manufacturer's instructions in the power cord entry hole below the access panel. At this time, the strain relief should be loosely in place.
4. Thread an UNPLUGGED, UL-approved, 30 amp. power cord, NEMA 14-30 type DRT or SRDT, through the strain relief.
5. Disconnect the internal (WHITE) dryer harness ground wire from the (GREEN) ground screw next to terminal block.
6. Attach the ground (GREEN) power cord wire to the cabinet with the ground (GREEN) screw. Tighten the screw securely.
7. Move the internal dryer harness ground (WHITE) wire to the terminal block and attach it along with the neutral (WHITE) power cord wire conductor to center, SILVER colored terminal on the terminal block. Tighten the screw securely.
8. Attach the RED and BLACK power cord conductors to the outer, BRASS colored terminals on the terminal block. Tighten both screws securely.



### WARNING

#### ELECTRICAL SHOCK HAZARD

**DO NOT** make a sharp bend or crimp wiring/conductor at connections.

9. Follow manufacturer's guidelines for firmly securing the strain relief and power cord.
10. Reinstall the terminal block cover.

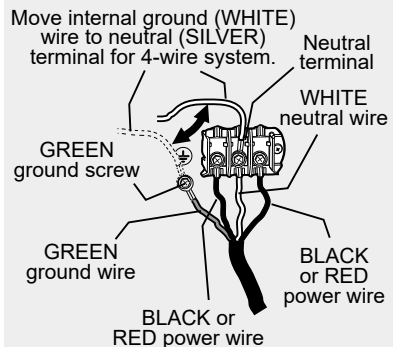
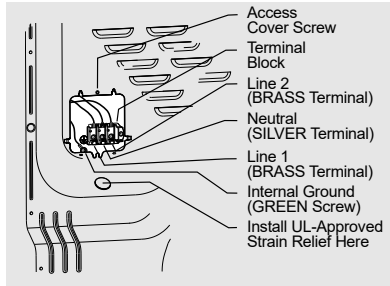
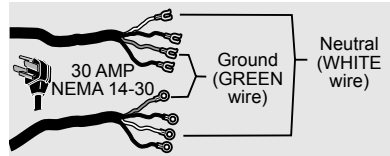

# 22 INSTALLATION

## Connecting the gas

This gas dryer comes from the factory with natural gas burner components installed. DO NOT operate this gas dryer, using LP (liquid propane) gas, unless the LP gas conversion kit has been properly installed by a qualified service personnel. Improper gas installation or LP conversion kit installation could result in injury or even death.

1. Remove the shipping cap from gas pipe at the rear of the dryer.



### WARNING

**DO NOT** connect the dryer to L.P. gas service without converting the gas valve. An L.P. conversion kit PN# PCK4200 (not included) **must be installed by a qualified gas technician.**

2. Connect a 1/2 inch (1.27 cm) I.D. semi-rigid or approved pipe from gas supply line to the 3/8 inch (0.96 cm) pipe located on the back of the dryer. Use a 1/2 inch to 3/8 inch (1.27 cm to 0.96 cm) reducer for the connection. Apply an approved thread sealer that is resistant to the corrosive action of liquefied gases on all pipe connections.

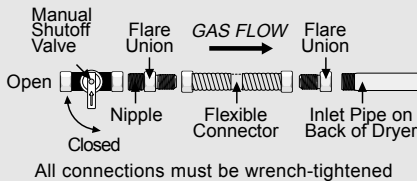

3. Open the shutoff valve in the gas supply line to allow gas to flow through the pipe. Wait a few minutes for gas to move through the gas line.



### IMPORTANT

The supply line must be equipped with an approved manual shutoff valve. This valve should be located in the same room as the dryer and should be in a location that allows ease of opening and closing. **DO NOT** block access to the gas shutoff valve.

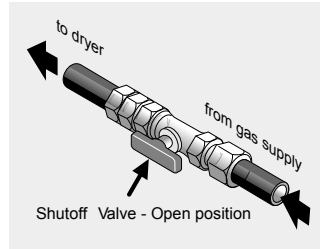

4. Check for gas system leaks with a manometer. If a manometer is not available, test all connections by brushing on a soapy water solution.



### WARNING

#### EXPLOSION HAZARD

NEVER test for gas leaks with an open flame.



### IMPORTANT

Installation to the gas service must follow local codes and ordinances and the latest edition of the National Fuel Gas Code ANSI Z223.1/NFPA 54 or in Canada, CSA B149.1.

## Connecting the water (steam models only)



### WARNING

Periodically inspect all water inlet hoses for water leaks, wear, cuts, corrosion and bulges. Replace all hoses, if any sign of the above is visible. All hoses should be replaced every 5 years to reduce the risk of hose failures.

## Water supply requirements

Cold water faucet MUST be installed within 42 inches (107 cm) of your dryer's water inlet. The faucet MUST be 3/4 inch (1.9 cm) with threading for laundry hose connection. Water pressure MUST be between 20 and 120 psi. Your water department can advise you of your water pressure.

1. Turn off COLD water supply to washer.

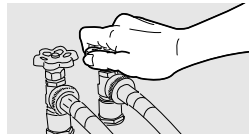

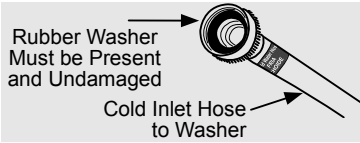

- Remove COLD inlet hose from COLD water supply and inspect for rubber washer. Replace washer if it is torn or worn out.

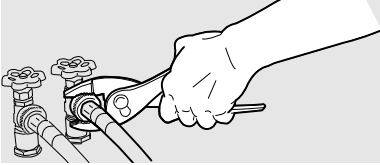

- Turn on COLD supply and run water to clear any contaminants in the line.



- Inspect hose couplings for proper placement of rubber washers. Use hoses from ASSEMBLY HOSE KIT# 5304495002 (not included).

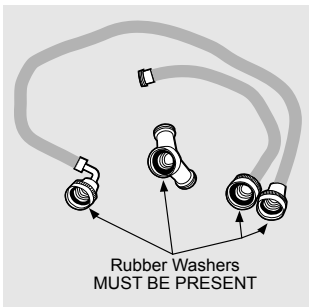

- If your installation has room for the COLD water supply to accept the "Y" connector directly, thread the "Y" connector to the COLD water supply and snug it by hand; then tighten it another 2/3 turn with pliers.

## NOTE

If you were able to install the "Y" connector directly to the COLD water supply, please skip to step 8.

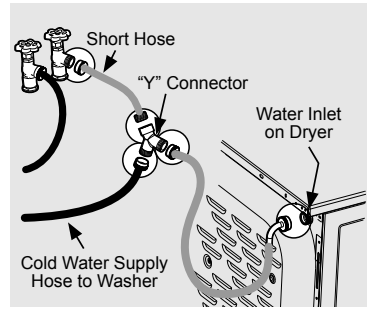

- If there is not room to install the "Y" connector directly, thread the short extension hose on to the COLD water supply and snug it by hand; then tighten it another 2/3 turn with pliers.

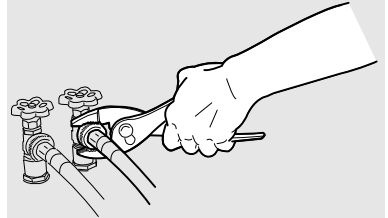

- Thread the "Y" connector to the short extension hose and snug it by hand; then tighten it another 2/3 turn with pliers.
- Connect the COLD inlet hose for the washer to the "Y" connector and snug it by hand; then tighten it another 2/3 turn with pliers.
- Connect the straight end of the long hose from the kit to the other outlet on the "Y" connector and snug it by hand. Connect the hose's 90° coupling to the brass water inlet on the back of the dryer and snug it by hand. Tighten each connection of the dryer inlet hose another 2/3 turn with pliers.
- Turn on the water and check for leaks at all connections.

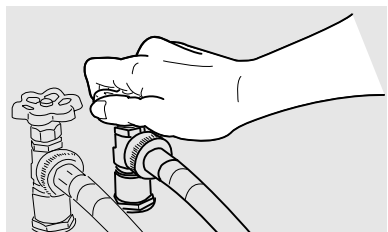

# 24 INSTALLATION

## Completing the installation

1. Connect the exhaust duct to the outside exhaust system. Use of a 4" (102 mm) clamp (item A) is recommended to connect the dryer to the exhaust vent system. Use metal foil tape to seal all other joints.

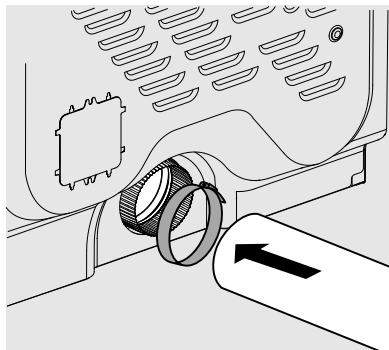

2. Use a carpenter's level to level your dryer front-to-back and side-to-side.
3. Use adjustable pliers to adjust the leveling legs so the dryer is level front-to-rear and side-to-side, and stable corner-to-corner.

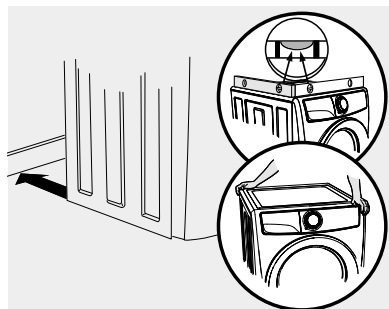

4. Press down on alternate corners and sides and feel for the slightest movement. Adjust the appropriate leg(s) so the dryer sits solidly on the floor on ALL four legs. Keep the leveling leg extension at a minimum for best performance of the dryer.

5. Plug the power cord into a grounded outlet.



### WARNING

Improper grounding of the dryer may cause serious injury or death. Check with a licensed electrician if you are in doubt as to whether the appliance is properly grounded.

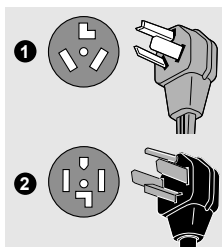

### WARNING

Do not store combustible materials, gasoline, and other flammable vapors and liquids near this dryer.

6. Turn on the power at the circuit breaker/fuse box.
7. Read the Use & Care Manual provided with the dryer. It contains valuable and helpful information that will save you time and money.
8. If you have any questions during initial operation, please review the "Avoid Service Checklist" in your Use & Care Manual before calling for service.
9. Place these instructions in a location near the dryer for future reference.



### NOTE

A wiring diagram and technical data sheet are located under the dryer top panel.



### IMPORTANT

Be sure the power is off at a circuit breaker/fuse box before plugging the power cord into an outlet.



### CAUTION

When discarding or storing your old dryer, remove the door.

## Reversing the door

### NOTE

Door reversibility is available on all dryer models.

### IMPORTANT

#### BEFORE YOU REVERSE YOUR DRYER DOOR:

1. Be sure you have adequate swing area before reversing door.
2. Gather your tools - including a screw driver with a #2 square bit and plastic knife (or small, flat prying tool that won't damage paint).
3. Be sure dryer is unplugged from power source!

Tools needed for reversal:

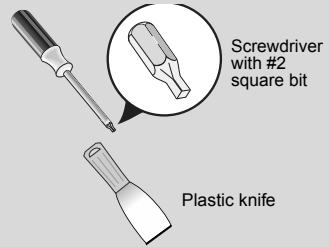

### WARNING

#### ELECTRICAL SHOCK HAZARD

Failure to disconnect power source before servicing could result in personal injury or even death.

## Removing latch and hole plugs

1. Open the door.
2. Remove plastic hole plugs and save to reinstall later. You may have to use a non-scratching plastic knife if you are unable to dislodge the plugs manually.

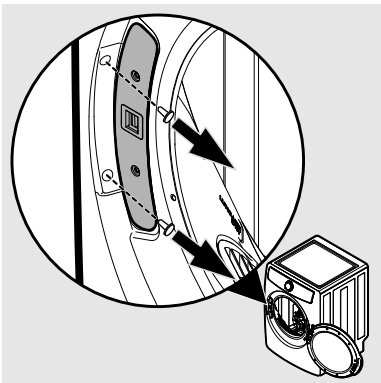

3. Remove both screws from door latch. Save latch and screws for reinstallation later.

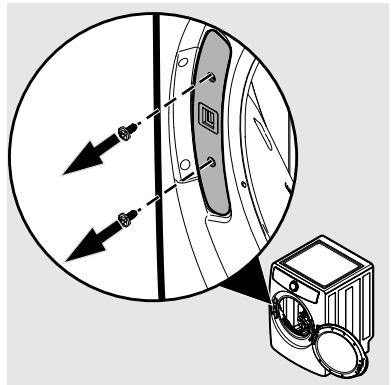

# 26

## INSTALLATION

### Removing Dryer Door Assembly

1. Open the door and remove screws with #2 square bit drive. Save for reinstallation.
2. Remove the door assembly and place on a cloth or towel on a flat surface.

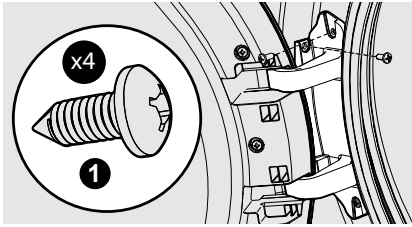

3. Remove the decorative caps from the front panel and save for reinstallation.

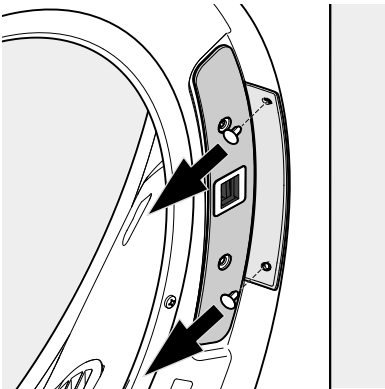
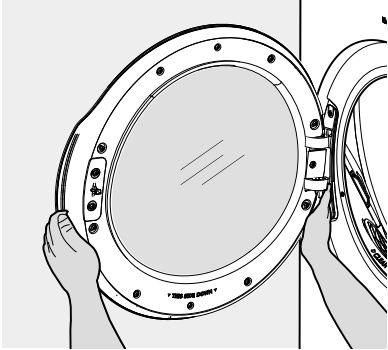

### Reversing Dryer Door Assembly

1. Locate and remove the two screws securing the latch. Save the screws and latch for reinstallation.

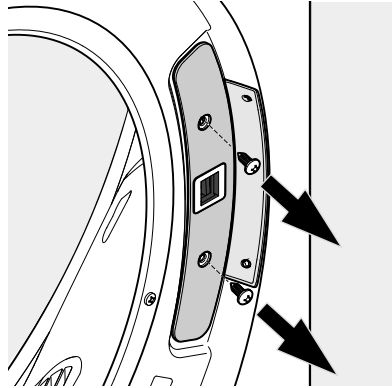

2. Locate and remove the two screws holding the striker. Save the screws and latch for reinstallation.

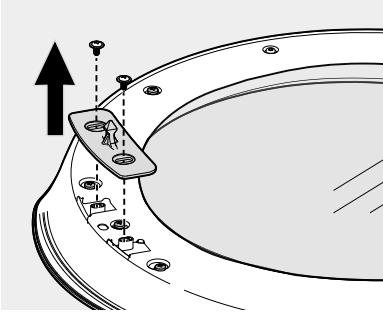

3. Remove remaining eight screws using a #2 square bit driver. Save the screws for reinstallation.

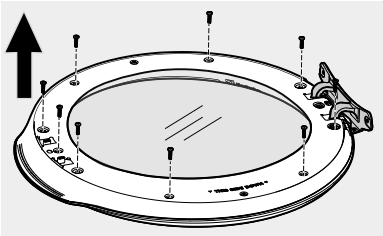

## IMPORTANT

Do not remove the torque screws at the twelve and 6 o'clock positions.

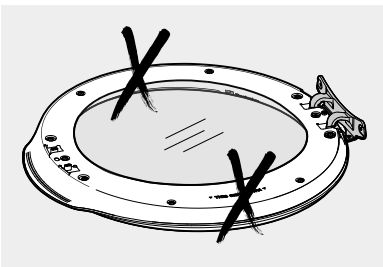

4. Lift the metal ring and rotate it 180 degrees, setting it back on the inner frame. Ensure gasket has not separated from the metal ring.

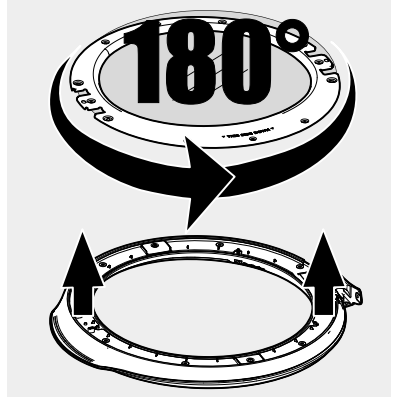

5. Make sure "THIS SIDE DOWN" on the metal ring point in the corresponding directions.

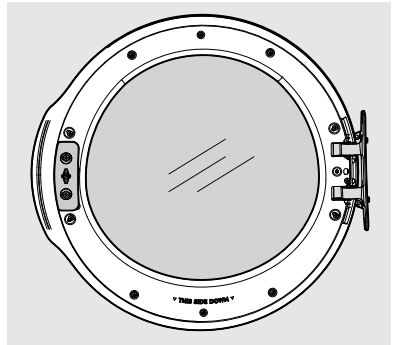

- Reinstall all eight screws using a #2 square bit driver.

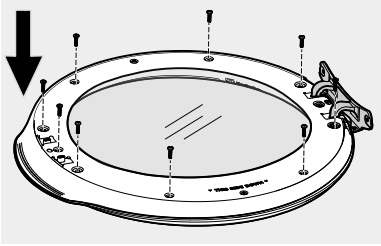

- Verify the gasket has not separated from the metal ring. Go back to step 5 if the gasket has separated.
- Reinstall the striker and previously removed screws.
- Reinstall the hinge cover.

### Reinstalling door Assembly

- Rotate the door and hang the upper hook on the back of the hinge in the upper hole of the front panel.

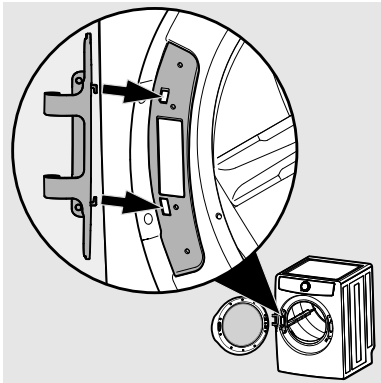

- Reinstall and tighten all four screws removed earlier - two front screws first, then the two side screws.

### Reinstalling Latch and Hole Plugs

- Install the door latch using the previously removed screws.

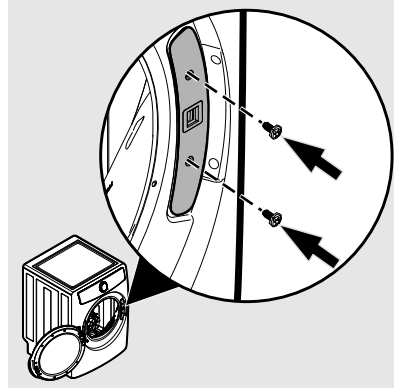

- Reinsert the plastic hole plugs.

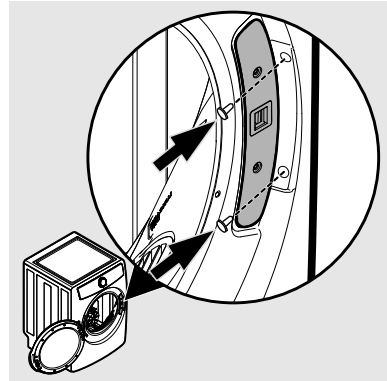

### Verify Reversed Dryer Door Operation

- Test the door for freely swinging, smooth operation and a secure latch when closed.
- Plug in the dryer and close the door. Start a test cycle: the drum should tumble until the door is pulled open or the cycle is paused or canceled.

## Accessories

### MATCHING STORAGE PEDESTAL\*

White Pedestal - P/N EPWD257UIW

Titanium Pedestal - P/N EPWD257UTT

A storage pedestal accessory, specifically designed for this dryer may be used to elevate the dryer for ease of use. This pedestal will add about 15" (38 cm) to the height of your unit.

\*Other colors may be available. Contact the source where you purchased your dryer.

### DRYER STACKING KIT

P/N STACKIT7X

Depending on the model you purchased, a kit for stacking a matching dryer on top of this washer may have been included in the initial purchase of your dryer. If your model did not include a stacking kit or you desire another stacking kit, you may order one.

### LP CONVERSION KIT

P/N PCK4200

Gas dryers intended for use in a location supplied with LP must use a conversion kit prior to installation.

### MOBILE HOME INSTALLATION KIT

P/N 137067200

Installations in mobile homes require use of MOBILE HOME INSTALLATION KIT.

### UNIVERSAL APPLIANCE WRENCH

P/N 137019200

A UNIVERSAL APPLIANCE WRENCH is available to aid in dryer/washer/pedestal feet adjustment.

### TOUCH UP PAINT PENS

White - P/N 5304468812

Titanium - P/N 5304475700

\*Other colors may be available. Contact the source where you purchased your dryer.

### ASSEMBLY HOSE KIT

P/N 5304495002

For use in dryer models that include a steam feature.



## WARNING

Failure to use accessories manufactured by (or approved by) the manufacturer could result in personal injury, property damage or damage to the dryer.

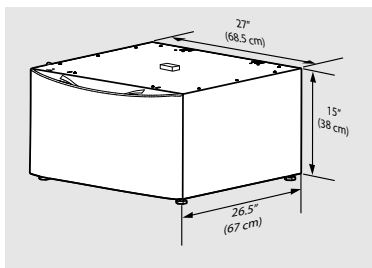

Storage Pedestal

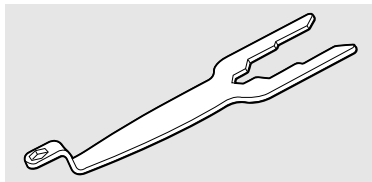

Universal Appliance Wrench

## Replacement parts in U.S. and Canada

If replacements parts are needed for your dryer, you can contact the source where you purchased your dryer, call 1-877-4ELECTROLUX (1-877-435-3287) in the U.S. or 1-800-265-8352 in Canada, or visit our website, [www.electrolux.com](http://www.electrolux.com) in the U.S. or [www.electrolux.ca](http://www.electrolux.ca) in Canada for the Electrolux Authorized Parts Distributor nearest you.

# 30 CONTROLS AND SETTINGS

## Model series

### 300 SERIES

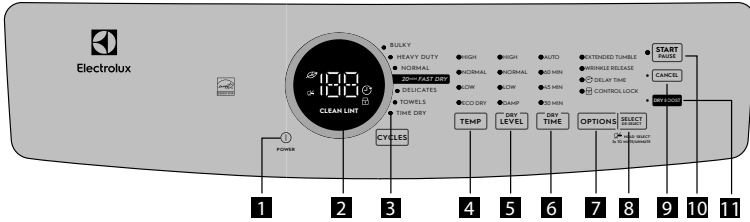

### 400 SERIES

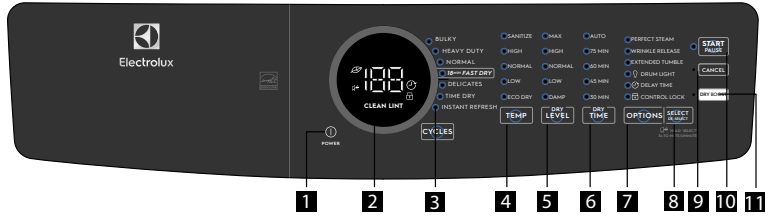

### 500 SERIES

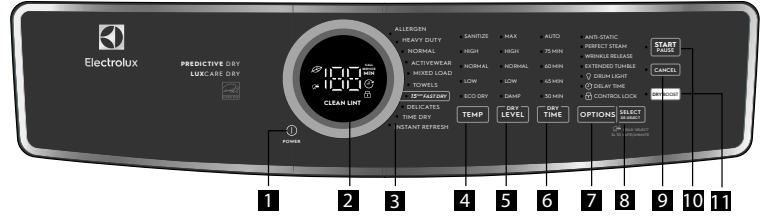

### 600 SERIES GAS/ELECTRIC

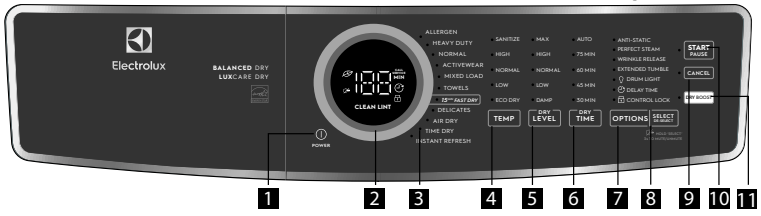

### 700 SERIES

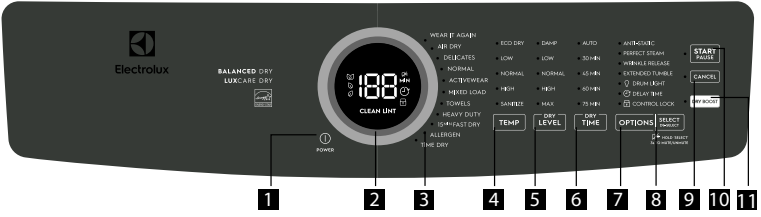

- 1** POWER
- 2** Cycle Selector
- 3** Cycle LED Display
- 4** Temp Selector
- 5** DRY LEVEL
- 6** DRY TIME
- 7** Options
- 8** SELECT/DE-SELECT
- 9** CANCEL
- 10** START/PAUSE
- 11** DRY BOOST

This manual covers many models and not all cycles, options, or features listed are available on every model. Consoles shown above for reference only. Your model may differ.

## Setting chart - 300 series dryer

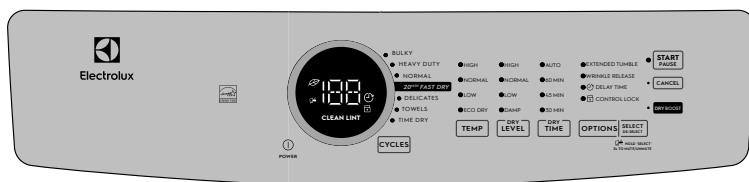

These temperature, dryness levels and options are available with the following cycles:

### CYCLE SELECTIONS

	BULKY	HEAVY DUTY	NORMAL	20 MIN FAST DRY	DELICATES	TOWELS	TIME DRY
--	-------	------------	--------	-----------------	-----------	--------	----------

### TEMPERATURE (temp)

High	✓	✓		✓		✓	✓
Normal		✓	✓			✓	✓
Low			✓		✓	✓	✓
Eco Dry							✓

### DRYNESS

High	✓	✓	✓			✓	
Normal		✓	✓		✓	✓	
Low			✓		✓		
Damp			✓		✓		

### Dry Time

Auto Dry	✓	✓	✓		✓	✓	
60 Min							✓
45 Min							✓
30 Min							✓

### OPTIONS

Extended Tumble	✓	✓	✓		✓	✓	✓
Wrinkle Release	✓	✓	✓		✓	✓	✓
Delay Time	✓	✓	✓	✓	✓	✓	✓
Control Lock	✓	✓	✓	✓	✓	✓	✓
Dry Boost	✓	✓	✓	✓	✓	✓	✓

✓ = Available selections. ◻ = Factory presets. ◼ = Non-modifiable presets.

CYCLE SETTINGS

CYCLE OPTIONS

# 32 CONTROLS AND SETTINGS

## Setting chart - 400 series dryer



These temperature, dryness levels and options are available with the following cycles:

### CYCLE SELECTIONS

BULKY	HEAVY DUTY	NORMAL	18 MIN FAST DRY	DELICATES	TIME DRY	INSTANT REFRESH
-------	------------	--------	-----------------	-----------	----------	-----------------

### TEMPERATURE (temp)

Sanitize	✓	✓				✓	
High	✓	✓		■		✓	■
Normal		✓	✓			✓	
Low			✓	■		✓	
Eco Dry						✓	

### DRYNESS

Max	■	✓	✓				
High		✓	✓				
Normal		✓	✓		✓		
Low			✓		✓		
Damp			✓		✓		

### DRY TIME

Auto Dry	■	✓	✓		■		
75 Min						✓	
60 Min						✓	
45 Min						✓	
30 Min						✓	

### OPTIONS

Perfect Steam			✓		✓		✓
Wrinkle Release	✓	✓	✓		✓	✓	
Extended Tumble	✓	✓	✓		✓	✓	
Drum Light (Available in White models only)	✓	✓	✓	✓	✓	✓	✓
Delay Time	✓	✓	✓	✓	✓	✓	✓
Control Lock	✓	✓	✓	✓	✓	✓	✓
Dry Boost	■	✓	✓	✓	✓	✓	

✓ = Available selections. ◻ = Factory presets. ■ = Non-modifiable presets.

CYCLE SETTINGS

CYCLE OPTIONS

## Setting chart - 500 series dryer



These temperature, dryness levels and options are available with the following cycles:

### CYCLE SELECTIONS

ALLERGEN	HEAVY DUTY	NORMAL	ACTIVE WEAR	MIXED LOADS (COLORS)	TOWELS	15 MIN FAST DRY	DELICATES	TIME DRY	INSTANT REFRESH
----------	------------	--------	-------------	----------------------	--------	-----------------	-----------	----------	-----------------

### TEMPERATURE (temp)

Sanitize	✓	✓				✓			✓
High	✓	✓		✓	✓	■		✓	■
Normal		✓	✓	✓	✓	✓		✓	
Low			✓	✓	✓	✓	✓	✓	
Eco Dry (No Heat/Air)								✓	

### DRYNESS

Max	■	✓	✓			✓			
High		✓	✓	✓	✓	✓			
Normal		✓	✓	✓	✓	✓	✓		
Low			✓	✓	✓			✓	
Damp			✓		✓			✓	

### DRY TIME

Auto Dry	■	✓	✓	✓	✓	■		■	
75 Min								✓	
60 Min								✓	
45 Min								✓	
30 Min								✓	

### OPTIONS

Anti-Static		✓	✓	✓	✓	✓		✓	
Perfect Steam			✓	✓	✓	✓		✓	✓
Wrinkle Release	✓	✓	✓	✓	✓	✓		✓	✓
Extended Tumble	✓	✓	✓	✓	✓	✓		✓	✓
Drum Light	✓	✓	✓	✓	✓	✓	✓	✓	✓
Delay Time	✓	✓	✓	✓	✓	✓	✓	✓	✓
Control Lock	✓	✓	✓	✓	✓	✓	✓	✓	✓
Dry Boost	■	✓	✓	✓	✓	✓	✓	✓	

✓ = Available selections. □ = Factory presets. ■ = Non-modifiable presets.

CYCLE SETTINGS

CYCLE OPTIONS

### Setting chart - 600 series dryer



These temperature, dryness levels and options are available with the following cycles:

#### CYCLE SELECTIONS

	ALLERGEN	HEAVY DUTY	NORMAL	ACTIVE WEAR	MIXED LOADS (COLORS)	TOWELS	15 MIN FAST DRY	DELICATES	AIR DRY	TIME DRY	INSTANT REFRESH
--	----------	------------	--------	-------------	----------------------	--------	-----------------	-----------	---------	----------	-----------------

#### TEMPERATURE (temp)

Sanitize	✓	✓				✓				✓	
High	✓	✓			✓	✓	■			✓	■
Normal		✓	✓	✓	✓	✓				✓	
Low			✓	✓	✓	✓		✓		✓	
Eco Dry (No Heat/Air)									✓	✓	

#### DRYNESS

Max	■	✓	✓			✓					
High		✓	✓	✓	✓	✓					
Normal		✓	✓	✓	✓	✓		✓			
Low			✓	✓	✓			✓			
Damp			✓		✓			✓	■		

#### Dry Time

Auto Dry	■	✓	✓	✓	✓	✓		✓	✓		
75 Min											✓
60 Min											✓
45 Min											✓
30 Min											✓

#### OPTIONS

Anti-Static		✓	✓	✓	✓	✓		✓			
Perfect Steam			✓	✓	✓	✓		✓			✓
Wrinkle Release	✓	✓	✓	✓	✓	✓		✓	✓	✓	
Extended Tumble	✓	✓	✓	✓	✓	✓		✓	✓	✓	
Drum Light	✓	✓	✓	✓	✓	✓		✓	✓	✓	✓
Delay Time	✓	✓	✓	✓	✓	✓		✓	✓	✓	✓
Control Lock	✓	✓	✓	✓	✓	✓		✓	✓	✓	✓
Dry Boost	■	✓	✓	✓	✓	✓	✓	✓		✓	

✓ = Available selections. ◻ = Factory presets. ■ = Non-modifiable presets.

CYCLE SETTINGS

CYCLE OPTIONS

## Setting chart - 700 series dryer

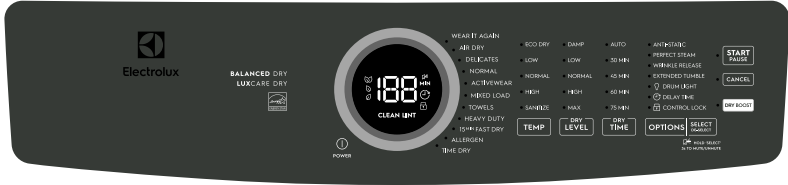

These temperature, dryness levels and options are available with the following cycles:

### CYCLE SELECTIONS

ALLERGEN	HEAVY DUTY	NORMAL	ACTIVE WEAR	MIXED LOADS (COLORS)	TOWELS	15 MIN FAST DRY	DELICATES	AIR DRY	TIME DRY	Wear it again
----------	------------	--------	-------------	----------------------	--------	-----------------	-----------	---------	----------	---------------

### TEMPERATURE (temp)

Sanitize	✓	✓				✓				✓
High	✓	✓		✓	✓	✓	■		✓	■
Normal		✓	✓	✓	✓	✓			✓	
Low			✓	✓	✓	✓	✓		✓	
Eco Dry (No Heat/Air fluff)								✓	✓	

### DRYNESS

Max	✓	✓	✓			✓				
High		✓	✓	✓	✓	✓				
Normal		✓	✓	✓	✓	✓	✓			
Low			✓	✓	✓		✓			
Damp			✓		✓		✓	✓		

### Dry Time

Auto Dry	✓	✓	✓	✓	✓	✓	✓	✓		
75 Min										✓
60 Min										✓
45 Min										✓
30 Min										✓

### OPTIONS

Anti-Static		✓	✓	✓	✓	✓		✓		
Perfect Steam			✓	✓	✓	✓	✓	✓		✓
Wrinkle Release	✓	✓	✓	✓	✓	✓	✓	✓	✓	✓
Extended Tumble	✓	✓	✓	✓	✓	✓	✓	✓	✓	
Drum Light	✓	✓	✓	✓	✓	✓	✓	✓	✓	✓
Delay Time	✓	✓	✓	✓	✓	✓	✓	✓	✓	✓
Control Lock	✓	✓	✓	✓	✓	✓	✓	✓	✓	✓
Dry Boost	✓	✓	✓	✓	✓	✓	✓		✓	

✓ = Available selections. ◻ = Factory presets. ■ = Non-modifiable presets.

CYCLE SETTINGS

CYCLE OPTIONS

# 36 CONTROLS AND SETTINGS

## Cycle selection

### Selecting the right cycle to save energy

This dryer has been specifically designed with options to help you save energy and at the same time utilize the optimal drying setting for your clothing.

**The energy efficiency rating is based on the Normal Cycle using the Normal temperature setting and the normal dryness level.**

Some cycles save more energy than others. Cycles that use the least amount of heat save the most energy and display the leaf icon  on the console. Use the lowest heat setting (auto and timed dry cycles) and less dry setting (auto dry cycles) to save on energy and prevent over drying your clothing.

Press the **power** button to turn on the unit. Turn the cycle selector in either direction or repeatedly press the cycles button (depending on your model) to scroll to the desired cycle. The indicator light for the cycle selected will be illuminated and the estimated drying time for Auto Dry cycles or the actual drying time for Time Dry cycles will be displayed on the LED display screen.

Default settings and options will automatically be indicated for the cycle selected. In most cases cycle settings and options can be changed. See *Cycle Settings*, *Cycle Options*, and *Setting Charts* for more details.

To change the cycle once it has begun, press the **cancel** button before selecting a new cycle. **Turning the cycle selector ring or pressing the cycles button WILL NOT change the cycle.**

### Auto dry cycles

Auto dry cycles take the guesswork out of selecting the correct drying time for each load. Moisture sensors sense the moisture level of the load as it tumbles through the heated air. With auto dry cycles, the load will automatically be dried at the selected temperature to the desired dryness level.

Auto dry cycles save time and energy and protect fabrics. When the load has reached the selected dryness level, it will continue to tumble, unheated, during a cool down period. This helps reduce wrinkling and makes items easier to handle during unloading.

### NOTE

Initial cycle times for auto dry cycles are only estimates, the actual drying time may differ slightly from the time displayed.

Drying times vary depending on size and dampness of the load and fabric type. If the load is too small or almost dry, the moisture

sensors may not detect enough moisture to continue the cycle and the cycle may end after a few minutes. If this occurs, then select the **time dry** cycle to dry such loads.

Room temperature and humidity, type of installation and electrical voltage or gas pressure can also affect drying time.

### NOTE

Models equipped with the **Predictive Dry** feature use the first 90 seconds of Auto Dry cycles to sense the load in the dryer. **During this 90 second period the LED display will show 2 circling lines.** When the sensing is complete, the LED display will show the remaining cycle time in minutes and accurately count down to the end of the cycle.

### Timed dry cycles

The timed drying cycles allow the selection of exact drying times. The **time dry** cycle allows the option to select drying time settings ranging from **30 to 75** minutes (depending on the model). Various drying times and temperature settings can be selected when using this cycle.

The **fast dry** cycles (on select models) have preset times of **15, 18 or 20** minutes (dependent on model) with a preset temperature of **high** only.

Dryness levels will not be an available option when using either of the timed drying cycles.

### WARNING

#### FIRE HAZARD

To avoid fire hazard, DO NOT use heat to dry items containing feathers or down, foam rubber, plastics similarly textured, rubber-like materials. Use the **time dry** cycle and the **eco dry** (no heat) setting.

## Cycles

LOAD	LOAD TYPE	CYCLE PRESET
<b>ALLERGEN</b> (select models)	Allergen removal (not for items prone to heat damage)	<ul style="list-style-type: none"> <li>high temperature*</li> <li>maximum dryness*</li> <li>auto dry*</li> </ul>
<b>BULKY</b> (select models)	Large loads and durable fabrics (such as towels, jeans and overalls)	<ul style="list-style-type: none"> <li>high temperature</li> <li>maximum dryness</li> <li>auto dry*</li> </ul>
<b>HEAVY DUTY</b> (select models)	Large loads and durable fabrics (such as jeans and overalls)	
<b>NORMAL</b>	Everyday loads (cottons, linens and sheets)	<ul style="list-style-type: none"> <li>normal temperature</li> <li>normal dryness</li> <li>auto dry*</li> </ul>
<b>ACTIVWEAR</b> (select models)	Lightweight synthetic athletic apparel (synthetic athletic fabrics and stretch fabrics)	<ul style="list-style-type: none"> <li>low temperature</li> <li>normal dryness</li> <li>auto dry*</li> </ul>
<b>MIXED LOAD</b> (select models)	Mixed load of fabrics	<ul style="list-style-type: none"> <li>normal temperature</li> <li>normal dryness</li> <li>auto dry*</li> </ul>
<b>TOWELS</b> (select models)	Large loads and durable fabrics (such as towels, jeans and overalls)	<ul style="list-style-type: none"> <li>high temperature*</li> <li>maximum dryness*</li> <li>auto dry*</li> </ul>
<b>FAST DRY</b> (varies by model) <b>15/18/20 min.</b>	Small loads of 3 to 5 garments	<ul style="list-style-type: none"> <li>high temperature*</li> <li>preset time* (15,18 or 20 minutes)</li> </ul>
<b>DELICATES</b>	Knit fabrics and delicates	<ul style="list-style-type: none"> <li>low temperature*</li> <li>normal dryness</li> <li>auto dry*</li> </ul>
<b>TIME DRY</b>	Manually set drying time, heat and dry level for any type of load	<ul style="list-style-type: none"> <li>normal temperature</li> <li>30-75 minutes time</li> </ul>
<b>AIR DRY</b>	Small loads of 3 to 5 garments	<ul style="list-style-type: none"> <li>no heat</li> </ul>
<b>INSTANT REFRESH</b> (select models)	Refresh fabrics, remove odors and reduce static by injecting steam into clothing.	<ul style="list-style-type: none"> <li>high temperature*</li> <li>perfect steam™*</li> </ul>
<b>WEAR IT AGAIN</b> (select models)	Optimized cycle to reduce odors, pet hair and wrinkles on slightly used clothing, allowing them to be worn once again before a complete washing cycle.	<ul style="list-style-type: none"> <li>high temperature*</li> <li>perfect steam™*</li> <li>preset time*</li> </ul>

\* setting can not be changed from preset



### NOTE

It is not recommended to use fabric softener sheets with steam cycles or steam options as it may cause staining on clothes.



### NOTE

To change a cycle setting once the cycle has begun, press the **start/pause** button, make the new selection and press **start/pause** again.

## Cycle settings

To set or change the drying temperature, dryness level, or drying time press the **temp**, **dryness** or **time dry** buttons to scroll to the desired settings. The indicator light for each setting will be illuminated when selected.

To protect your fabrics, not all temperatures or dryness levels are available with every cycle. If a temperature or dryness level is not appropriate for the cycle, it cannot be selected and will not be lit when scrolling through the settings.

# 38 CONTROLS AND SETTINGS

With exception of the **sanitize** and **perfect steam™**, adjustments made to cycle settings and options will be remembered and recalled each time that cycle is selected in the future.

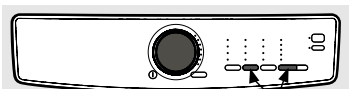

To return to factory settings, press the **dryness** and **options** buttons at the same time and hold until the signal sounds.

## Drying temperature (temp)

To change the temperature, press the **temp** button to scroll to the desired setting.



### For best results

Follow the fabric care label instructions on items to be dried.

### sanitize (on select models)

Recommended for durable fabrics and towels. Use this selection to remove harmful bacteria from your clothing or other items where sanitization is desired. This option will kill 99.9% of bacteria using a higher temperature required to kill bacteria. Please check fabric care labels to prevent damage.

### high

Recommended for most cotton fabrics.

### normal

Recommended for wrinkle free, easy care, lightweight fabrics and bulky loads.

### low (on select models)

Recommended for delicate fabrics.

### eco dry (no heat)

This setting should only be used with a time dry cycle to dry items containing feathers, down, foam rubber, plastics or rubber-like materials; to refresh clothing, stuffed animal, pillows or blankets; and to dust draperies.

## Dryness level (dryness)

To set or change the dryness level, press the **dryness** button to scroll to the desired setting.

The dryness levels include **max** (on select models), **high**, **normal**, **low** (on select models), and **damp**. Most Auto Dry cycles default to the **normal** dryness level.

Occasionally a load may seem too damp or over-dried at the end of the cycle. To increase drying time for similar loads in

the future, select **high** or **max** (on select models). To decrease drying time for similar loads, select **less** (on select models).

Select **damp** for items you wish to partially dry before hanging or ironing.

## Drying time (time dry)

Manually select or change the drying time for a **time dry** cycle (on select models) by pressing the **time dry** button to scroll through the available options. Time dry options include **30, 45, 60 and 75** minutes (dependent on model).

The **auto** selection is a default for all **auto dry** cycles and **fast dry** cycles and cannot be selected or changed. All actual or predicted dry times will count down on the LED display.

## Cycle options

To select an option, press **options** and scroll through the options until the indicator light for the desired option flashes, then press **select (set)**. The indicator will illuminate when the option has been selected. Follow the same steps to deselect an option. The indicator light will turn off when the option is deselected.

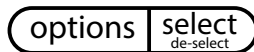

### NOTE

To change a cycle option once the cycle has begun, press the **start/pause** button, make the new selection and press **start/pause** again.

To protect your fabrics, not all options are available with every cycle. If an option is not available for a cycle, the indicator will not light.

Occasionally, two options or settings in the same cycle will conflict with each other, like the **perfect steam** option and **sanitize** temperature (on select models). When this happens, the option selected first will cause the conflicting option to not be selectable.



**perfect steam™ (on select models)** The **perfect steam™** option injects steam into the clothing prior to cool down to reduce wrinkling, ironing and static cling.

## NOTE

It is not recommended to use fabric softener sheets with steam cycles or steam options as it may cause staining on clothes.

### anti-static (on select models)

The **anti-static** option injects steam into the clothing just before cycle completion to reduce static.

### dry boost

This option increases the drying effectiveness for heavier fabrics or bulky loads by increasing the drying temperature by less than 20°F (>1°C). (Varies based on cycle selection).

### leaf icon

This icon will appear on the console when the dryer is using energy efficient settings. These settings use less heat and longer cycle times to dry. The dryer will always default to the energy efficient Normal cycle with the leaf icon displayed. For 700 models, the eco indicator has 3 levels: the higher the number of leaves, the more eco friendly.

### wrinkle release

The **wrinkle release** option helps prevent wrinkles and tangling by tumbling the dry load without heat for 5 minutes out of every 10 minutes. The 5 minutes on and 5 minutes off is repeated for a total 45 minutes. A chime will sound after each tumble as a reminder to remove the dried load.

## NOTE

When **extended tumble** and **wrinkle release options are both selected** the amount of time the load will tumble without heat will increase to a period of up to 75 minutes.

### extended tumble (on select models)

Select the **extended tumble** option if the dried load might not be removed promptly at the end of the cycle. The dried load will tumble continuously without heat for 30 minutes. A chime will sound periodically to remind you to remove the dried load.

### delay time (on select models)

Use **delay time** to delay the start of the drying cycle to a time convenient to your schedule or during off-peak energy hours. The start of any cycle can be delayed for 30 minutes to 12 hours. After selecting the delay time option, use the cycle button

(models 300/400) or the cycle selector (models 500/600/700) to scroll to the desired delay time and press **start**. The **delay time** icon will illuminate on the LED display to indicate the **delay time** option is activated. The delay time will begin counting down on the LED display once activated.

## NOTE

While counting down during **delay time**, you will notice your dryer periodically tumbling for a few minutes without heat to redistribute the load, maximizing load freshness.

### control lock

To lock the controls between cycles, scroll to the control lock option and press **select**. The control lock icon will show on the LED display. To unlock the controls scroll to the control lock option again and press **select**. Use this feature to reduce the likelihood of accidental operation by children. **Dryer cycles will not run when Control Lock is activated.**

### chime

A signal will sound at the end of the cycle (and periodically during **extended tumble** or **wrinkle release**). To mute or unmute the chime, press and hold the **select** button for **3** seconds.

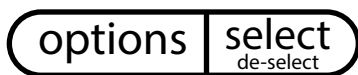

 hold 'select' 3 s to mute/unmute

## Other features

### LED display

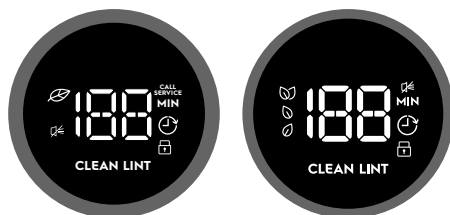

*Icons may vary according to model.*

The estimated cycle time for **auto dry**, the actual time for **time dry**, or the **delay time countdown** will be displayed when the cycle is selected. Once the cycle has started, the estimated remaining time will be displayed for the remainder of the cycle.

Models equipped with the Predictive Dry feature use the first 90 seconds of Auto Dry cycles to sense the load in the dryer. During this 90 second period the LED display shows 2 circling lines. When the sensing is complete, the LED display shows the remaining cycle time in minutes and accurately count down to the end of the cycle.

**Delay time**, **leaf**, **control lock**, **mute** icons (select models) and **CLEAN LINT** will also appear on this LED display when activated.

#### Drum light (on select models)

The drum light will come on whenever the door is opened to illuminate the drum during loading and unloading. Closing the door turns off the light. The drum light will automatically turn off if the door is left open more than 3 minutes. Select the **drum light** option to enable or disable the drum light.

#### Reversible door

The dryer is equipped with a reversible door. The door can be hinged on the right or left side.

#### NOTE

For step-by-step instructions on door reversal, refer to the *installation* sections of this manual.

#### LuxCare™ Lint Shield filter

The dryer is equipped with a clamshell style LuxCare™ Lint Shield filter.

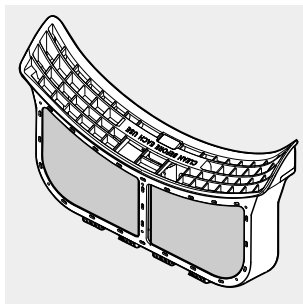

#### WARNING

Clean the filter after every load. A **CLEAN LINT message** will appear on the LED display at the end of the cycle to remind you to remove the lint from the filter.



#### NOTE

For step-by-step instructions cleaning the lint filter, refer to *Cleaning the Filter* in the Care and Cleaning section of this Use & Care Manual.

Operating the dryer



**WARNING**

To reduce the risk of fire, electric shock or injury to persons, read the Important Safety Information in this *Use & Care Manual* before operating your dryer.



**WARNING**

DO NOT operate dryer without lint filter in place.



**WARNING**

Clean the lint filter after every load.

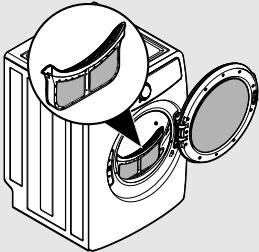
STEPS	TIPS	IMPORTANT
<p>1. Prepare load for drying.</p>	<ul style="list-style-type: none"> <li>• Dry items of similar fabric, weight and construction in the same load.</li> <li>• Separate dark items from light-colored items. Separate items that shed lint from those that attract lint.</li> <li>• Check for stains which may not have been removed in washing. Repeat stain removal process and wash again before drying. Dryer heat may permanently set some stains.</li> <li>• Place delicate, rubber coated, or small items in a mesh bag (not included).</li> <li>• Be sure buckles, buttons and trim are heatproof and won't damage the drum finish. Close zippers; fasten hooks and loop fasteners. Tie strings and sashes to prevent snagging and tangling.</li> </ul>	<p><b>DO NOT</b> machine wash items containing fiberglass. Small particles of fiberglass left in drum may transfer to fabrics in other loads and cause skin irritation and/or damage to fabrics.</p> <p><b>DO NOT</b> wash water resistant and water repellent type clothing or other materials.</p>
<p>2. Check that the lint filter is clean and in place.</p>		<p><b>DO NOT</b> operate dryer without lint filter in place.</p>
<p>3. Load the dryer and close the door.</p>	<ul style="list-style-type: none"> <li>• Load items loosely. The average wet load will fill the drum 1/3 to 1/2 full. Items need room to tumble freely for even drying and less wrinkling.</li> <li>• If desired, place a dryer fabric softener sheet on top of the load at the beginning of the cycle.</li> <li>• When drying large items, dry only two or three items at a time. Fill out the load with smaller items.</li> <li>• For delicate or very small loads, add two or three similar items to improve tumbling action.</li> </ul>	<p>DO NOT overload the dryer. To save energy, time and avoid uneven drying and wrinkling avoid overloading the dryer.</p> <p>DO NOT over-dry. Over-drying can cause wrinkles, shrinkage, lint, and a build up of static electricity.</p>

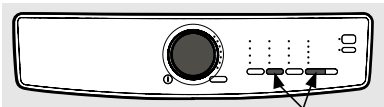
STEPS	TIPS	IMPORTANT
<p>1. Select the appropriate cycle and settings for each load.</p>	<ul style="list-style-type: none"> <li>• See <i>Cycle Selection</i> and <i>Cycle Settings</i> for detailed descriptions of cycle controls.</li> <li>• See <i>Cycle Setting Charts</i> to determine which settings are available for each cycle.</li> <li>• To provide the best care, not every setting or option is available with every cycle. If a setting or option is not available for the cycle selected, the indicator will not light. See <i>Setting Chart</i> for information of available options for each cycle by model.</li> <li>• Adjustments made to most cycle settings will be remembered each time the cycle is selected in the future. When the dryer is powered on, the default cycle will be the normal cycle. Select your desired cycle and previous settings will remain. To return to factory settings, press the dryness button and the options button at the same time and hold until the signal sounds.</li> </ul> 	<p>Over-drying can cause wrinkles, shrinkage, lint, harshness, and a build up of static electricity.</p> <p>To prevent unintentional and accidental exposure of delicate material to excess heat or unexpected steam, the <b>sanitize</b> temperature setting and the <b>perfect steam™</b> option will not be remembered and must be reselected each time.</p>
<p>2. Close the dryer door and start the drying cycle.</p>	<ul style="list-style-type: none"> <li>• To start the drying cycle, close the door and press the <b>start/pause</b> button.</li> <li>• To add an item to the dryer drum, press <b>start/pause</b>. Add the item, close the door and press <b>start/pause</b> to resume the cycle.</li> <li>• To change settings or options after the cycle has begun, press <b>start/pause</b>, change the settings, and then press <b>start/pause</b>. If the cycle is not paused first, the unit will emit several beeps when the buttons are pressed but no changes to the cycle will be applied.</li> <li>• To change the cycle once the cycle has begun, press <b>cancel</b> to cancel the cycle, select the new cycle, and press <b>start/pause</b> to begin the new cycle. Changing a cycle selection without cancelling the current <b>WILL NOT</b> change the cycle.</li> <li>• To cancel a cycle, press <b>cancel</b>.</li> </ul>	<p>The dryer <b>will not</b> operate with the door open.</p> <p>When drying a single large or bulky item, such as a comforter, pause the cycle part way through to turn the item “inside out” and maximize drying effectiveness.</p>
<p>3. Remove items when done.</p>	<ul style="list-style-type: none"> <li>• A signal will sound at the end of the cycle if the chime option is not set to mute.</li> <li>• Immediately remove items when the cycle is completed and hang or fold.</li> </ul>	<p>See product manufacturer’s instructions.</p>
<p>4. Clean the lint filter.</p>	<ul style="list-style-type: none"> <li>• See Care and Cleaning section of this instruction.</li> <li>• <b>CLEAN LINT</b> will be displayed at the end of the cycle as a reminder to remove lint from filter.</li> </ul>	<p><b>ALWAYS REMOVE LINT at the end of the cycle (see warning on previous page).</b></p>

## Normal operating sounds

You may or may not hear the following sounds from your new dryer:

1. **WATER VALVE** (Steam models only.)  
The flow of water is controlled by electric solenoids. During operation there may be a clicking sound as the valve opens and closes to control the water flow.
2. **SUSPENSION ROLLERS** The dryer drum is supported by a set of suspension rollers. At times there may be a thumping or rolling sound when the dryer starts. This may happen if the dryer has not been in use for a period of time, or after a heavy load has remained in the dryer drum for an extended period, creating a temporary flat spot on the edge of the roller. The noise should dissipate as the dryer operates and the flat spots smooth out.
3. **AIR FLOW SYSTEM** Your dryer is equipped with a high volume air handling system. In some installations there may be some sounds associated with air movement throughout the dryer, including the air duct, blower, and exhaust system. This is normal and can vary with load size and type.
4. **GAS VALVE** (Gas models only.) The flow of gas is controlled by electric solenoids. During operation there may be a clicking sound as the valve opens and closes to control the gas flow.
5. **GAS BURNER** (Gas models only.) When the burner is operating, there may be sounds generated as the air flow mixes with the gas flame. This noise is normal and will only occur when the gas is ignited in the combustion tube.

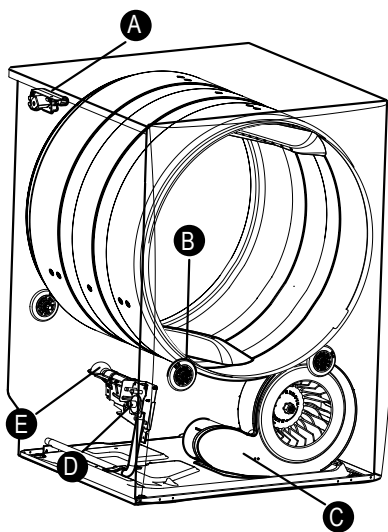

### Before operating your dryer

Read the important instructions in this section of the *Use & Care Manual* before operating your dryer.



#### WARNING

To reduce the risk of fire, electric shock or injury to persons, read the Important Safety Information in this *Use & Care Manual* before operating your dryer.

**WARNING**

To reduce risk of fire or serious injury to persons or property, comply with the basic warnings listed in the Important Safety Information and those listed below.

**Cleaning the filter****WARNING**

Clean the lint filter after every load. **CLEAN LINT** will be displayed at the end of the cycle to remind you to remove lint from the filter.

Clean the lint filter after every load. Lint build-up on the filter restricts air flow, which causes longer drying times. The filter is located at the bottom of the door opening.

**Cleaning the LuxCare™ Lint Shield filter**

1. Remove the filter by pulling it straight up from the dryer.

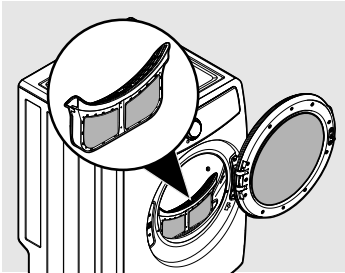

2. Press down the button on the top of the filter to open the clamshell.

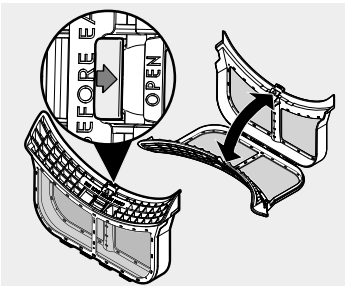

3. Gently clean the lint from the filter.

4. Snap the filter closed and place back into the dryer.

**IMPORTANT**

- DO NOT open the clamshell filter beyond the hinge limit.
- ALWAYS handle the clamshell filter by the frame, not by the mesh material.

**Inside**

- Occasionally a waxy build-up may form on the lint filter and/or moisture sensing bars from using dryer-added fabric softener sheets. To remove this build-up, wash them with warm, soapy water. Dry the filter thoroughly and replace. **DO NOT** operate the dryer without the lint filter in place.
- If the dryer drum becomes stained from non colorfast fabrics, clean the drum with a damp cloth and a mild liquid household cleanser. Remove cleanser residue before drying the next load.
- Before cleaning the dryer drum interior, unplug the electrical power cord to avoid electrical shock hazards.
- **DO NOT** use any type spray cleanser when cleaning the dryer interior. Hazardous fumes or electrical shock could occur.
- **Every 18 months a qualified service professional should clean the dryer cabinet interior, lint screen housing and exhaust duct. These areas can collect lint and dust over time. An excessive amount of lint build-up could result in inefficient drying and possible fire hazard.**

**Outside**

- Clean the dryer cabinet with mild soap and water. Never use harsh, gritty or abrasive cleansers.
- If the cabinet becomes stained, clean with diluted chlorine bleach (1 part bleach to 8 parts water). Rinse several times with clear water.
- Remove glue residue from tape or labels with a mixture of warm water and mild detergent. Or, touch residue with the sticky side of the tape or label.

- When cleaning chrome parts, it is best to use only a damp cloth.
- Before moving the dryer, place a strip of cardboard or thin fiberboard under the front leveling legs to prevent damage to the floor.



## WARNING

### FIRE HAZARD

A clothes dryer produces combustible lint. The dryer must be connected to an outdoor exhaust. Regularly inspect the outdoor exhaust opening and remove any accumulation of lint around the opening and in the surrounding area.



## IMPORTANT

DO NOT store or place laundry products on top of dryer at any time. They can damage the finish or controls. It is recommended to keep laundry products in the storage drawer between cycles if installed on a pedestal.



## Water inlet hose inspection (steam models only)

Periodically inspect all water inlet hoses for water leaks, wear, cuts, corrosion and bulges. Replace all hoses, if any sign of the above is visible. All hoses should be replaced every 5 years to reduce the risk of hose failures. When replacing hoses, refer to the *installation instructions* for proper installation. DO NOT overtighten or cross

thread the fittings. DO NOT allow the hose to rub against sharp objects. Always ensure the hose fitting rubber gasket is installed and free from water leaks when water pressure is applied.

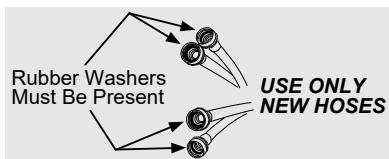

## Limited use, vacation, and away from home



## CAUTION

Your dryer should be operated ONLY when you are home. If you are away from home or not using your dryer for extended periods of time, follow these steps:

1. Turn off the water supply to dryer (steam models only) to avoid water leaks due to water pressure surges and unforeseen occurrences in the water supply.
2. Disconnect or unplug the electrical power to the dryer.

## Reconnecting water supply and electrical



## IMPORTANT

When reinstalling the dryer after disconnecting the water supply lines (steam models only) and electrical power, please follow the steps below:

1. Review the *installation instructions* provided with the dryer to ensure the appliance is level and the water and electrical power supply is properly connected.
2. Ensure the water lines are flushed of debris, prior to connecting the water lines to the dryer inlet.
3. Check for water leaks and replace supply hoses if needed.

## Common drying inquiries

Many drying problems involve poor cleaning results, poor soil and stain removal, residues of lint and scum, and fabric damage. For satisfactory drying results, follow these suggestions provided by The Soap and Detergent Association.

PROBLEM	POSSIBLE CAUSES	SOLUTIONS	PREVENTIVE MEASURES
Greasy, oily stains	<ul style="list-style-type: none"> <li>Fabric softener sheet</li> </ul>	<ul style="list-style-type: none"> <li>Rub fabric softener stains with bar soap. Rinse and rewash.</li> </ul>	<ul style="list-style-type: none"> <li>Add a few bath towels to small loads for proper tumbling.</li> <li>Some "silk-like" fabrics should be air dried.</li> <li>Use proper drying temperature.</li> <li>Place fabric softener sheet on top of load before starting the dryer.</li> </ul>
Lint	<ul style="list-style-type: none"> <li>Overloading</li> <li>Overdrying causes static electricity</li> <li>Lint screen not clean when cycle began</li> <li>Lint is attached to "pills"</li> </ul>	<ul style="list-style-type: none"> <li>Reduce load size and rewash using liquid fabric softener in the final rinse.</li> <li>Or, add a fabric softener sheet and tumble without heat.</li> <li>Use lint brush or roller to remove lint.</li> </ul>	<ul style="list-style-type: none"> <li>DO NOT overload dryer.</li> <li>Use fabric softener in washer or dryer to reduce static electricity.</li> <li>Remove items when they are slightly damp to avoid overdrying.</li> <li>Check that lint filter is clean and in place.</li> </ul>
Pilling (fibers break off, ball up and cling to fabric)	<ul style="list-style-type: none"> <li>Overdrying</li> </ul>	<ul style="list-style-type: none"> <li>Use a lint brush or shaver to remove pills.</li> </ul>	<ul style="list-style-type: none"> <li>Use fabric softener to lubricate fibers.</li> <li>When ironing, use spray starch or fabric finish on collars and cuffs.</li> <li>Turn items inside out to reduce abrasion.</li> </ul>
Shrinking	<ul style="list-style-type: none"> <li>Temperature too high</li> <li>Overdrying</li> </ul>	<ul style="list-style-type: none"> <li>Irreversible condition.</li> </ul>	<ul style="list-style-type: none"> <li>Follow fabric care label directions.</li> <li>If shrinking is a concern, check load often.</li> <li>Remove items while slightly damp and hang or lay flat to complete drying.</li> <li>Block knits into shape.</li> </ul>
Wrinkling	<ul style="list-style-type: none"> <li>Overloading</li> <li>Leaving items in dryer after cycle ends</li> </ul>	<ul style="list-style-type: none"> <li>Reduce load size and tumble at medium or low heat for 5-10 minutes.</li> <li>Remove items immediately. Hang or fold.</li> </ul>	<ul style="list-style-type: none"> <li>DO NOT overload dryer.</li> <li>Remove items as soon as cycle ends.</li> </ul>
Isolated wet spots on fabrics after completed Steam cycle	<ul style="list-style-type: none"> <li>Low water pressure in home is not sufficient to atomize incoming water during steam cycle</li> </ul>	<ul style="list-style-type: none"> <li>Check water line pressure.</li> </ul>	<ul style="list-style-type: none"> <li>Ensure water line pressure is minimum of 20 psi. DO NOT exceed 120 psi.</li> </ul>

## Before calling

Before calling for service, review this list. It may save both time and expense. The list includes common occurrences that are not the result of defective workmanship or materials in this dryer.

PROBLEM	POSSIBLE CAUSES	SOLUTIONS
Dryer does not start.	<ul style="list-style-type: none"> <li>• Electrical power cord is not securely plugged in or plug may be loose.</li> <li>• House fuse blown or circuit breaker tripped.</li> <li>• Action of pressing start button on "touch screen" style console not recognized.</li> <li>• Thermal limiter tripped.</li> <li>• Delay time inadvertently activated.</li> <li>• Door may be open. Unit will not operate with door open.</li> <li>• Difficult load to dry.</li> </ul>	<ul style="list-style-type: none"> <li>• Make sure the plug fits tightly in wall outlet.</li> <li>• Reset circuit breaker or replace fuse.</li> <li>• Make sure electrical line is not overloaded and the dryer is on a separate circuit.</li> <li>• Press start button with bare fingertip.</li> <li>• Call authorized service person for replacement.</li> <li>• Ensure delay time not activated.</li> <li>• Ensure door is closed.</li> <li>• Select Dry Boost option</li> </ul>
LED displays "dr".	<ul style="list-style-type: none"> <li>• Dryer has been programmed to temporarily perform a repeating demo cycle.</li> </ul>	<ul style="list-style-type: none"> <li>• Reset the unit back to factory default settings as described earlier.</li> </ul>
Dryer runs but won't heat.	<ul style="list-style-type: none"> <li>• There are 2 house fuses in the dryer circuit. If 1 of the 2 fuses is blown, the drum may turn but the heater will not operate (electric models).</li> <li>• Gas supply valve is not open (gas models).</li> <li>• Dryer does not have enough air supply to support the burner flame (gas models).</li> <li>• LP gas supply tank is empty or there has been a utility interruption of natural gas (gas models).</li> </ul>	<ul style="list-style-type: none"> <li>• Replace fuse.</li> <li>• Check to make sure supply valve is open. Refer to the <i>installation instructions</i> provided with the dryer.</li> <li>• See the <i>Installation sections of this manual</i>.</li> <li>• Refill or replace tank. Dryer should heat when utility service is restored.</li> </ul>

PROBLEM	POSSIBLE CAUSES	SOLUTIONS
Drying cycle takes too long, outside of the dryer feels too hot or smells hot.	<ul style="list-style-type: none"> <li>• Lint filter is clogged with lint.</li> <li>• Exhaust duct requirements have not been met.</li> <li>• Electric dryer is connected to a 208 volt circuit.</li> <li>• Drying procedures have not been followed.</li> <li>• Outside exhaust hood or exhaust duct may be clogged or restricted.</li> <li>• High humidity.</li> </ul>	<ul style="list-style-type: none"> <li>• Make sure all lint has been removed from the dryer lint filter before starting each cycle.</li> <li>• Exhaust duct must be at least 4 inches in diameter and made of rigid or semi-rigid metal.</li> <li>• When in place, the duct must not exceed length listed in the <i>installation instructions</i>.</li> <li>• Drying time will be 20% longer than drying on a 240 volt circuit.</li> <li>• See <i>Operating Instructions</i>.</li> <li>• Clean out any obstruction.</li> <li>• Use a dehumidifier near the dryer.</li> </ul>
Excess moisture in drum between cycles.	<ul style="list-style-type: none"> <li>• Exhaust damper stuck open or not present.</li> </ul>	<ul style="list-style-type: none"> <li>• Fix or clean the damper, or install new one.</li> </ul>
Excessive wrinkling.	<ul style="list-style-type: none"> <li>• Dryer is overloaded.</li> <li>• Items left in dryer too long.</li> <li>• Insufficient sorting of items.</li> <li>• Drying temperature too high.</li> <li>• Drying load is very small.</li> </ul>	<ul style="list-style-type: none"> <li>• DO NOT overload. See <i>Operating Instructions</i>.</li> <li>• Remove items as soon as cycle ends.</li> <li>• See <i>Operating Instructions</i>.</li> <li>• Follow fabric care label instructions.</li> <li>• Add two or three larger items.</li> </ul>
Scratching or chipping of the drum finish.	<ul style="list-style-type: none"> <li>• Foreign objects such as coins, pins, clips or buttons are inside the dryer.*</li> <li>• Permanently attached items such as belt buckles, zippers and fasteners may be hitting the inside of the drum.*</li> </ul>	<ul style="list-style-type: none"> <li>• Always remove foreign objects from pockets before laundering. Remove objects from drum and restart dryer.</li> <li>• It may be necessary to sew a scrap of material securely around ornaments before drying to prevent scratching and damage to the dryer.</li> </ul>
<p>* Drum damage caused by foreign objects or permanently attached items is not covered by the warranty.</p>		

For the applicable warranty period as set forth below, as measured from your original date of delivery, Electrolux will repair or replace any parts of this appliance that prove to be defective in materials or workmanship when such appliance is installed, used and maintained in accordance with the provided instructions.

### Warranty Periods:

- All parts — One year including labor. In addition, your appliance is covered by a one year, parts only, limited warranty. During the 2nd year from your original date of purchase, Electrolux will pay for parts needed for this appliance that have proven to be defective in materials or workmanship when your appliance is installed, used, and maintained in accordance with the provided instructions.

### Exclusions

This warranty does not cover the following:

1. Products with original serial numbers that have been removed, altered or cannot be readily determined.
2. Product that has been transferred from its original owner to another party or removed outside the USA or Canada.
3. Rust on the interior or exterior of the unit
4. Products purchased "as-is" are not covered by this warranty.
5. Products used in a commercial setting.
6. Service calls which DO NOT involve malfunction or defects in materials or workmanship, or for appliances not in ordinary household use or used other than in accordance with the provided instructions.
7. Service calls to correct the installation of your appliance or to instruct you how to use your appliance.
8. Expenses for making the appliance accessible for servicing, such as removal of trim, cupboards, shelves, etc., which are not a part of the appliance when it is shipped from the factory.
9. Service calls to repair or replace appliance light bulbs, air filters, water filters, other consumables, or knobs, handles, or other cosmetic parts.
10. Pickup and delivery costs; your appliance is designed to be repaired in the home.
11. Surcharges including, but not limited to, any after hour, weekend, or holiday service calls, tolls, ferry trip charges, or mileage expense for service calls to remote areas, including the state of Alaska.
12. Damages to the finish of appliance or home incurred during transportation or installation, including but not limited to floors, cabinets, walls, etc.
13. Damages caused by: services performed by unauthorized service companies; use of parts other than genuine Electrolux parts or parts obtained from persons other than authorized service companies; or external causes such as abuse, misuse, inadequate power supply, accidents, fires, or acts of God.

### DISCLAIMER OF IMPLIED WARRANTIES; LIMITATION OF REMEDIES

CUSTOMER'S SOLE AND EXCLUSIVE REMEDY UNDER THIS LIMITED WARRANTY SHALL BE REPAIR OR REPLACEMENT AS PROVIDED HEREIN. **CLAIMS BASED ON IMPLIED WARRANTIES, INCLUDING WARRANTIES OF MERCHANTABILITY OR FITNESS FOR A PARTICULAR PURPOSE, ARE LIMITED TO ONE YEAR OR THE SHORTEST PERIOD ALLOWED BY LAW, BUT NOT LESS THAN ONE YEAR.** ELECTROLUX SHALL NOT BE LIABLE FOR CONSEQUENTIAL OR INCIDENTAL DAMAGES SUCH AS PROPERTY DAMAGE AND INCIDENTAL EXPENSES RESULTING FROM ANY BREACH OF THIS WRITTEN LIMITED WARRANTY OR ANY IMPLIED WARRANTY. SOME STATES AND PROVINCES DO NOT ALLOW THE EXCLUSION OR LIMITATION OF INCIDENTAL OR CONSEQUENTIAL DAMAGES, OR LIMITATIONS ON THE DURATION OF IMPLIED WARRANTIES, SO THESE LIMITATIONS OR EXCLUSIONS MAY NOT APPLY TO YOU. THIS WRITTEN WARRANTY GIVES YOU SPECIFIC LEGAL RIGHTS. YOU MAY ALSO HAVE OTHER RIGHTS THAT VARY FROM STATE TO STATE.

### If You Need Service

Keep your receipt, delivery slip, or some other appropriate payment record to establish the warranty period should service be required. If service is performed, it is in your best interest to obtain and keep all receipts. Service under this warranty must be obtained by contacting Electrolux at the addresses or phone numbers below.

This warranty only applies in the USA, Puerto Rico and Canada. In the USA and Puerto Rico, your appliance is warranted by Electrolux Consumer Products, Inc. In Canada, your appliance is warranted by Electrolux Canada Corp. Electrolux authorizes no person to change or add to any obligations under this warranty. Obligations for service and parts under this warranty must be performed by Electrolux or an authorized service company. Product features or specifications as described or illustrated are subject to change without notice.

Though Electrolux makes every effort to make replacement parts, repair services and information necessary to maintain or repair our products available to consumers, parts, service and information are not guaranteed, pursuant to section 39 of the Consumer Protection Act, CQLR, c. P-40.1 and sections 79.18 to 79.20 of the Regulation respecting the application of the Consumer Protection Act, CQLR, c P-40.1, r. 3.

If you need replacement parts, you may call us at 1 (800) 265-8352 for service in French or English.



You may book repair services online at [support.electrolux.ca/repairs/information](https://support.electrolux.ca/repairs/information)

Alternatively, our resource library is available at [support.electrolux.ca/support-articles](https://support.electrolux.ca/support-articles) to help you diagnose and resolve issues which may arise during the lifetime of your appliance.

Though most parts are available for purchase, subject to short-term availability constraints, the following appliances and parts are not serviceable.

### Legend

#### Availability of replacement parts, repair services, and information for maintenance or repair.

	Partially Available
	Not Available
	Available

<b>Washers and Dryers</b>		Replacement parts, repair services, and information for repair and maintenance available.
---------------------------	---	---

USA  
1-877-435-3287

Electrolux Consumer Products, Inc.,  
North America  
10200 David Taylor Drive  
Charlotte, NC 28262



Canada  
1-800-265-8352  
Electrolux Canada Corp.  
5855 Terry Fox Way  
Mississauga, Ontario, Canada  
L5V 3E4



CE



A20448908 (December 2025)