

FRIGIDAIRE

GALLERY.



Freezer

FGCH25M8LW

Manual Defrost
25 Cu. Ft. Chest



Product Dimensions

Height (Including Lid)	35"
Width	73-1/4"
Depth	29-1/2"

More Easy-To-Use Features

Bright Lighting

Our bright lighting makes it easy to see what's inside.

Power-On Indicator Light

Know at a glance that your freezer is working.

Adjustable Temperature Control

Select the correct temperature for your needs.

Lock with Pop-Out Key

The freezer key automatically ejects after locking the door so you won't leave it in the door.

Defrost Water Drain

Use the drain to conveniently remove water during defrosting.

Color-Coordinated Handle



ENERGY STAR®

Available in:



White
(W)

Signature Features

SpaceWise® Organization System

Heavy-duty dividers allow you to organize food storage like never before. System includes and accommodates pre-printed storage labels.

Store-More™ Removable Basket

Convenient lift-out storage for easy access to most small frozen items or items that are most frequently used.

ENERGY STAR® Qualified

Built with American Pride

Appliances that are high-performing, more accessible, and more innovative than ever — designed, built, and engineered in the U.S.A.

Features	
Defrost	Manual
Adjustable Temperature Control	Yes
Interior Lighting	Bright
Store-More™ Removable Baskets	3
Food Organization System	Yes
Defrost Water Drain	Yes
Lid Handle	Yes
Lock with Pop-Out Key	Yes
Power-On Light	Yes
Certifications	
ENERGY STAR®	Yes
CSA Rating	Household
Specifications	
Total Capacity (Cu. Ft.)	24.6
Annual Energy (kWH)	508
Annual Energy Cost (.1065/kWH)	\$54
Power Supply Connection Location	Bottom Rear
Voltage Rating	115V / 60Hz / 5A
Connected Load (kW rating) @ 115 Volts¹	.6
Amps @ 115 Volts	5
Minimum Circuit Required (Amps)	15
Shipping Weight (Approx.)	224 Lbs.

¹An electrical supply with grounded three-prong receptacle is required. The power supply circuit must be installed in accordance with current edition of National Electrical Code (NFPA 70) and local codes & ordinances.

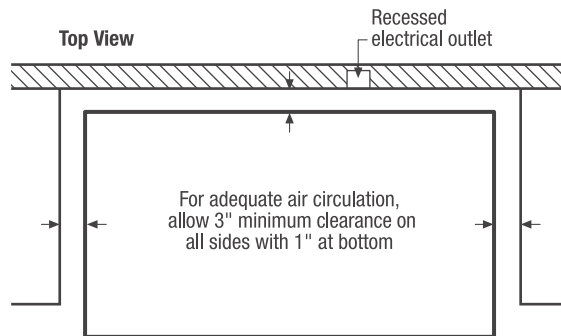
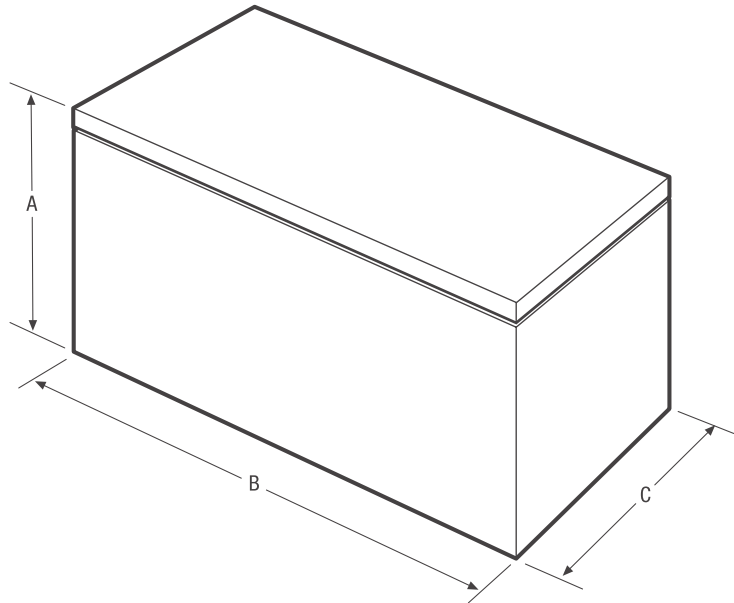

NOTE: For planning purposes only. Always consult local and national electric codes. Refer to Product Installation Guide for detailed installation instructions on the web at frigidaire.com.



Product Dimensions	
A - Height (Including Lid)	35"
B - Width	73-1/4"
C - Depth	29-1/2"
Height with Lid Open 90°	60-13/16"

Accessories information available on the web at frigidaire.com

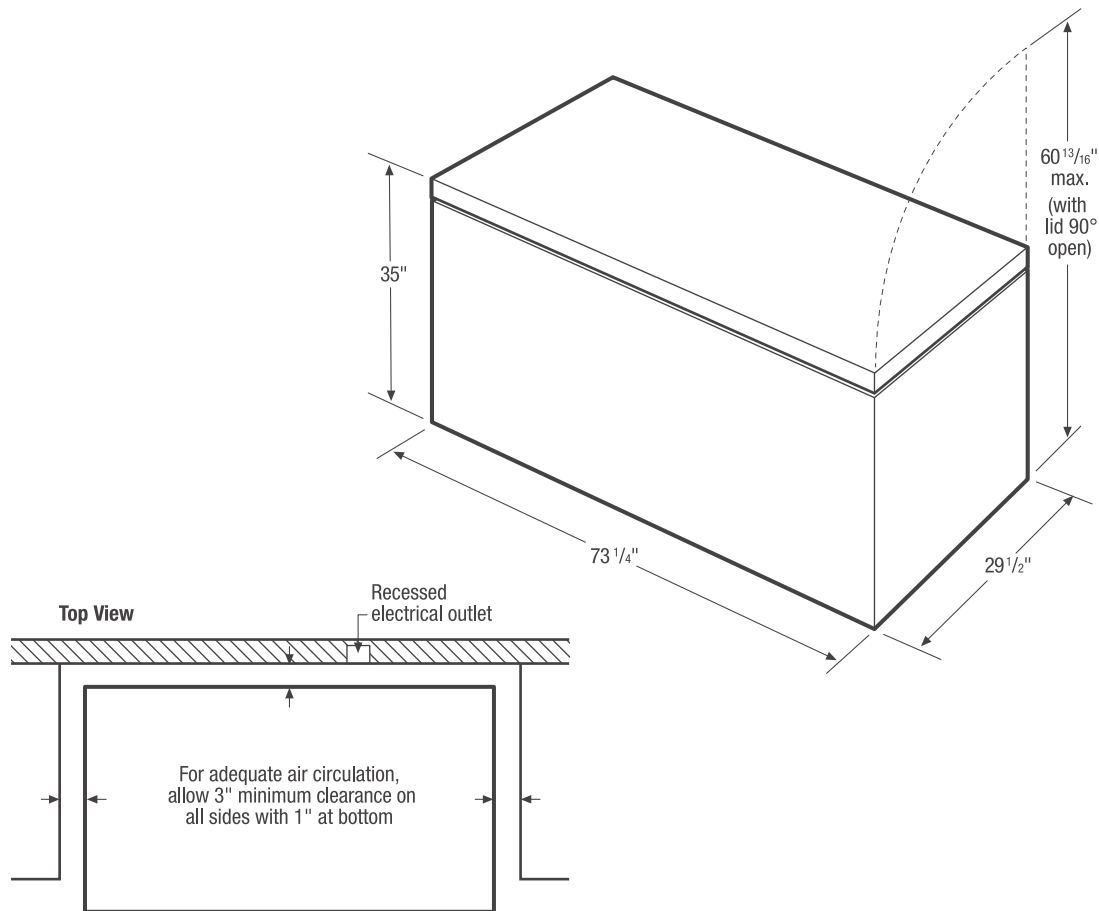

Chest Freezer Specifications

- Product Shipping Weight (approx.) - 224 Lbs.
- An electrical supply with grounded three-prong receptacle is required. The power supply circuit must be installed in accordance with current edition of *National Electrical Code (NFPA 70)* and local codes & ordinances.
- Voltage Rating - 115V/60 Hz/5 Amps
- Connected Load (kW Rating) @115 Volts = 0.6 kW
- Amps @115 Volts = 5 Amps
- Always consult local and national electric codes.
- For adequate air circulation, allow 3" minimum clearance on all sides with 1" at bottom.
- Locate where surrounding air temperature will not exceed 110° F, to ensure optimum performance. (Temperatures 32° F and below will NOT affect operation.)
- All bottom corners of unit MUST rest firmly on solid level surface of hard material, same height as flooring. Surface must be strong and stable enough to support unit when fully loaded.
- Equipped with adjustable leveling legs to ensure unit is level, which is required in order to function properly.

Note: For planning purposes only. Refer to Product Installation Guide on the web at frigidaire.com for detailed instructions.